

SV4401A

Handheld Vector Network Analyzer

User Manual

Rev. 1.0

(For firmware 0.1.2)

TABLE OF CONTENTS

1.	Introduction.....	- 1 -
1.1.	About SV4401A.....	- 1 -
1.2.	Features.....	- 2 -
1.3.	Specifications.....	- 3 -
2.	Appearance.....	- 5 -
3.	Main screen.....	- 7 -
4.	Menus.....	- 14 -
4.1.	STIMULUS.....	- 14 -
4.1.1	SET FREQUENCY.....	- 14 -
4.1.2	L/C MATCH.....	- 15 -
4.1.3	IFBW.....	- 16 -
4.1.4	POWER.....	- 17 -
4.1.5	AVG.....	- 17 -
4.1.6	SWEEP POINTS.....	- 18 -
4.2.	MARKER.....	- 19 -
4.2.1	SELECT MARKER.....	- 19 -
4.2.2	SEARCH.....	- 19 -
4.2.3	INFO SET.....	- 20 -
4.2.4	DRAG ON.....	- 21 -
4.3.	CAL.....	- 21 -
4.3.1	RESET.....	- 21 -
4.3.2	CALIBRATE.....	- 21 -
4.4.	SAVE/RECALL.....	- 25 -
4.4.1	RECALL.....	- 25 -
4.4.2	SAVE.....	- 25 -
4.5.	FILE.....	- 26 -
4.6.	CONFIG.....	- 29 -
4.7.	STORAGE.....	- 29 -
4.7.1	SAVE S1P.....	- 29 -
4.7.2	SAVE S2P.....	- 30 -

4.8.	RUN/PAUSE.....	- 30 -
5.	Physical buttons.....	- 30 -
5.1.	screenshot.....	- 30 -
5.2.	Specify marker frequency.....	- 30 -
5.3.	Add marker.....	- 30 -
5.4.	Delete marker.....	- 30 -
5.5.	Switch marker.....	- 30 -
6.	User defined information.....	- 31 -
7.	PC software.....	- 31 -
8.	Console Command.....	- 32 -
8.1.	Get serial port number.....	- 32 -
8.2.	Serial tools.....	- 33 -
8.3.	Command Syntax.....	- 34 -
8.4.	Command Description.....	- 34 -
8.4.1	help.....	- 34 -
8.4.2	reset.....	- 34 -
8.4.3	data.....	- 34 -
8.4.4	frequencies.....	- 35 -
8.4.5	scan.....	- 35 -
8.4.6	sweep.....	- 36 -
8.4.7	pause.....	- 36 -
8.4.8	resume.....	- 36 -
8.4.9	marker.....	- 37 -
8.4.10	version.....	- 37 -
8.4.11	info.....	- 37 -
8.4.12	sn.....	- 38 -
8.4.13	resolution.....	- 38 -
9.	Firmware upgrade.....	- 38 -
10.	Hardware architecture.....	- 41 -
11.	Shipping list.....	- 41 -

1. Introduction

1.1. About SV4401A

SV4401A is a handheld Vector Network Analyzer (VNA) with frequency range of 50kHz ~ 4.4GHz. It can be used for S11 and S21 measurements. The S21 dynamic range of SV4401A is 75 dB, while the S11 dynamic range is 50 dB.

SV4401A is suitable for antenna testing of MF/HF/VHF/UHF bands, such as shortwave antennas, ISM band antennas, WiFi antennas, Bluetooth antennas, GPS antennas, etc. It can also be used to measure filters, amplifiers, attenuators, cables, power dividers, couplers, duplexers and other RF components. SV4401A supports a variety of display formats: Log Mag, Linear Mag, Phase, Smith R+jX, Smith R+L/C, VSWR, Polar, Group delay, Resistance, Reactance, etc. In addition, SV4401A supports TDR function which is useful for cable lengths measurement.

SV4401A is designed with metal case, which is durable and can effectively shield electromagnetic interference. The dimension of SV4401A is 190mmx130mmx30mm, and a back bracket is designed for desktop use. The RF interface of SV4401A is N-type female connector and a pair of N-to-SMA adapters are included, which can be used to connect DUTs with SMA interfaces.

With the optimally designed signal processing system, the scan speed of SV4401A is 400 points/s, which enables a quasi-real-time measurement, and the maximum scanning points is up to 1001. The screen of SV4401A is a 7-inch high-brightness IPS capacitive touch screen, which allows users to see the screen content clearly in outdoor. SV4401A adopts a full touch screen design, with 4 physical buttons, users can quickly set frequency range, scale, turn on/off traces, add/delete markers, screenshots, and so on. The operation is quite convenient and smooth.

The SV4401A has two built-in 3350mAh 18650 lithium batteries with a battery life of up to 4 hours. The charging interface is USB Type-C, and the included Type-C cable can be used to charge the device and also for data transfer. Besides, SV4401A has a built-in 8GB memory card, which can be used to store calibration status, snp files, screenshots, etc.

1.2. Features

- Frequency range : 50kHz - 4.4GHz;
- S21 dynamic range : 75dB, S11 dynamic range : 50dB;
- 7-inch high-brightness IPS capacitive touch screen, clearly visible outdoors ;
- Metal case, effectively shield electromagnetic interference;
- N-type RF connector, stable and durable;
- Full touch screen + 4 physical buttons, convenient and smooth operation;
- Dimensions: 190mmx130mmx30mm;
- Designed with a back bracket for desktop operation;
- Supports local screenshot, able to save the screenshot to the built-in memory card;
- Built-in 8GB memory card to store calibration status, snp files, screenshots, etc;
- 2 built-in 3350mAh 18650 lithium batteries with a battery life of up to 4 hours;
- TDR function, which can be used to measure cable length;
- Up to 2 reference traces;
- Up to 8 markers, and the marker table can be dragged to anywhere on the screen;
- 12 save/recall slots, and supports save/recall calibration state from files;
- Charging via USB Type-C, and the charging voltage is 5V DC;
- Designed with a 5V/1A USB power output port;
- Firmware upgrade via virtual U disk with USB Type-C cable;
- Comes with SMA calibration kit and 50cm SMA coaxial cable;
- Screen brightness adjustable;
- Automatic sleep to save power;
- Supports console commands and PC software;
- Comes with a storage bag;

1.3. Specifications

Parameter	Specification	Conditions
Frequency range	50kHz ~ 4.4GHz	
RF power out	-42dBm ~ -12dBm	step : 1dB
RF connectors	N-type female	Come with N to SMA adapters
RF power in	0dBm (Max)	DC < 5V
Frequency accuracy	< ±1 ppm	< 140MHz
	< ± 5kHz	> 140MHz
S21 Dynamic range ¹	75dB	< 3GHz
	60dB	> 3GHz
S11 Dynamic range ¹	50dB	< 3GHz
	40dB	> 3GHz
Sweep points	1001	Can be set to 101-1001
Sweep speed	400 pts/s	f > 140MHz
IFBW	12.5kHz (default)	12.5k/6.25k/3.12k/1k/300Hz/100Hz/30Hz
Smoothing	Arithmetic mean	Average: 1 ~ 25
Traces	7	4 data traces, 2 reference traces, 1 TDR trace
Markers	8	
Calibration state storage	12	Calibration states can be stored as files to the built-in memory card
Storage capacity	8GB	TF memory card
Display	7-inch IPS LCD	Resolution: 1024x600
Operation mode	Capacitive touch and physical buttons	
Screenshot	On device	
Power consumption	5W	

Battery life time	4 hours	50% brightness
Battery	18650 lithium battery	3.6V/3350mAh×2
Charge/Data port	USB Type-C	
Charge voltage	4.7V ~ 5.5V	Recommended to charge with 5V/2A
USB power output	5V/1A	
Dimensions	190mmx130mmx30mm	RF connector not included
Shell material	Iron	
Weight	1.15kg	
	1.65kg	Includes accessories and packaging
Operating Temperature	0C° -45C°	

- Dynamic range specifications are reported under the condition of 12.5kHz IFBW and 1x averaging. Reducing the IFBW and increasing the averaging times will improve dynamic range, while the sweep speed will drop.

2. Appearance

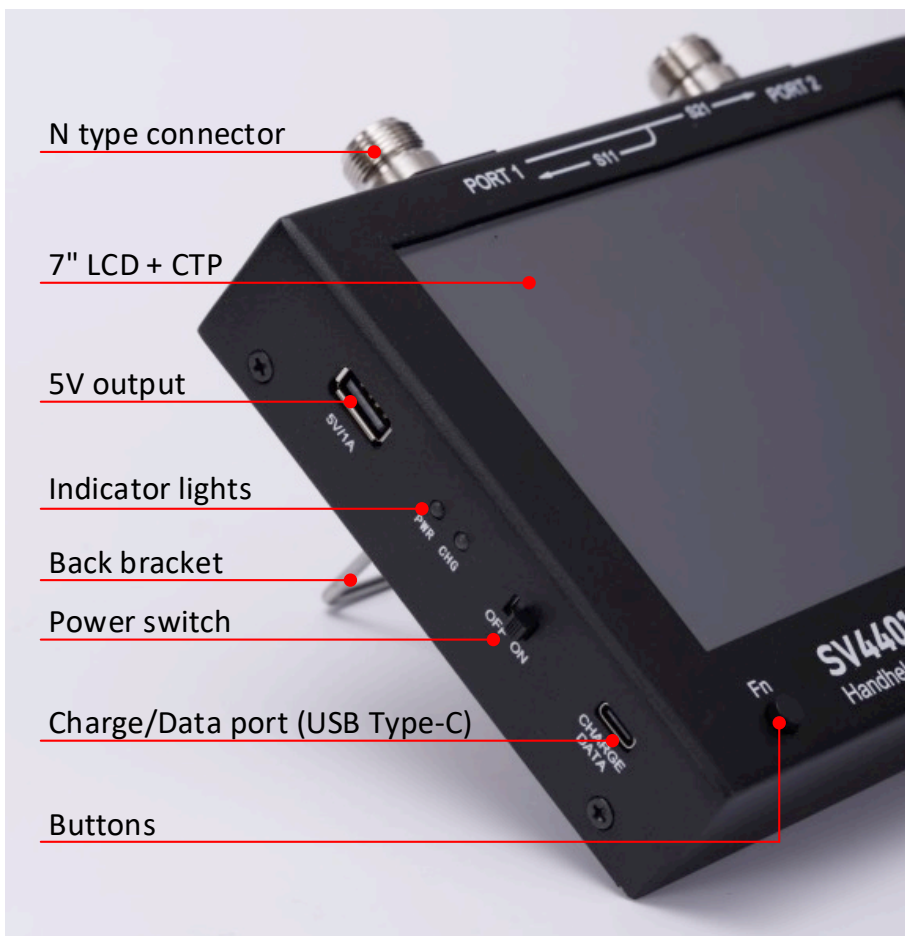



3. Main screen

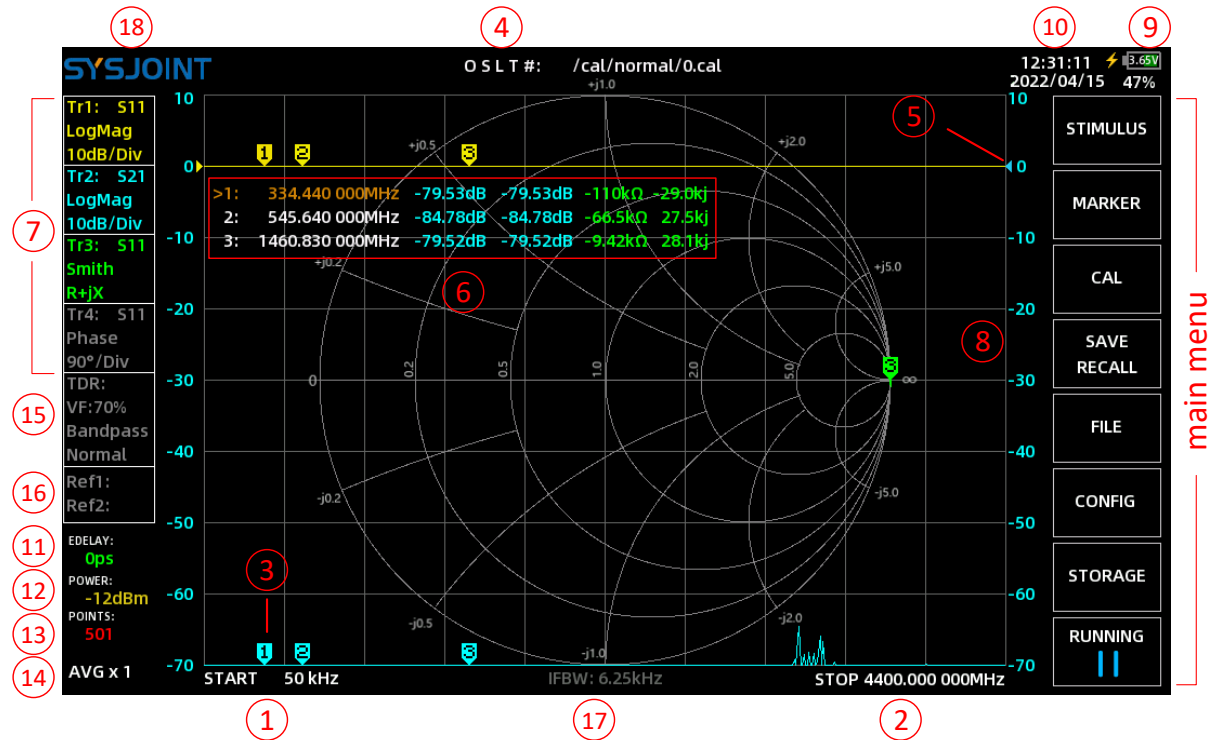

① Start frequency

The start frequency is displayed in this area.

Touch on this area to quickly set the start frequency.

② Stop frequency

The stop frequency is displayed in this area.

Touch on this area to quickly set the stop frequency.

③ Marker

Up to 8 markers can be displayed at the same time on the screen.

You can move the marker with the following 2 ways:

- (1) Push the button ◀ or ▶ ;
- (2) Directly drag the marker on the screen;

④ Calibration status

O Indicates that OPEN calibration has been performed ;

S Indicates that SHORT calibration has been performed ;

L Indicates that LOAD calibration has been performed;

T Indicates that THROUGH calibration has been performed;

'#' Indicates that the device has been calibrated;

'*' Indicates that the calibration state has not been stored and will be lost after powered off;

The string following '#' corresponds to the calibration file path;

To quickly recall the calibration state, please select **[SAVE/RECALL]** → **[RECALL]** → **[RECALL n]** ;

To recall the calibration state from a .cal file, please select **[SAVE/RECALL]** → **[RECALL]** → **[RECALL FILE]** , then select the specified file to recall the calibration state.

⑤ Reference position

A triangular arrow indicates the reference position of the trace, and the arrow has the same color with the trace.

Long-press on the trace control box will call up the trace setting menu, select **[Ref position]** to set the reference position of the corresponding trace. The bottom grid line corresponds to reference position 0, and the top grid line corresponds to reference position 8.

⑥ Marker Table

Up to 8 sets of marker information can be displayed at the same time in the marker table, and each of the marker information set includes frequency and 4 other parameters.

The marker table can be dragged freely on the screen.

To quickly activate a marker, you should touch on the frequency value region of the corresponding marker information set of the marker table. A '>' symbol indicates the current active marker.

You can open, select, or close a marker by:

[MARKER] → **[SELECT MARKER]** → **[MARKER n]**

The display style of the marker table is configurable by **[MARKER]** → **[INFO SET]** .

⑦ Trace control box

There are 4 slots in the trace control box.

You can get the information of channel, format, scale, and on/off status of the corresponding trace from the trace control box.

Touch on the trace control slot will turn on/off the corresponding trace.



In the above figure Tr2 is taken as an example, read it as follows:

Tr2 : S21 indicates that the trace presents S21, the format of Tr2 is **Log Mag. 10dB/Div** indicates that the ordinate is 10dB per division.

If the text color of the trace control slot is gray, that means the trace has been turned off, as Tr4 shown in the above figure.

⑧ Ordinate

The left ordinate corresponds to the scale of Tr1 by default, and the right ordinate corresponds to the scale of Tr2 by default.

It is also possible to reconfigure the ordinate by **[MARKER]** → **[INFO SET]** .

You can touch on the ordinate area to quickly set the trace scale.

⑨ Battery info

This area shows the battery voltage, battery level and charging status (⚡).

A low battery warning sign (⚠) will appear when the battery level is too low.

⑩ Time and date

This area displays the time and date.

To set the time and date, please navigate to **[CONFIG]** on the main menu.

⑪ Electrical delay

Electrical delay value is displayed here.

Touch on this area to set the Electrical delay.

Electrical delay is used to specify a delay time in nanoseconds (ns) or picoseconds (ps) to compensate the delay introduced by connectors or cables.

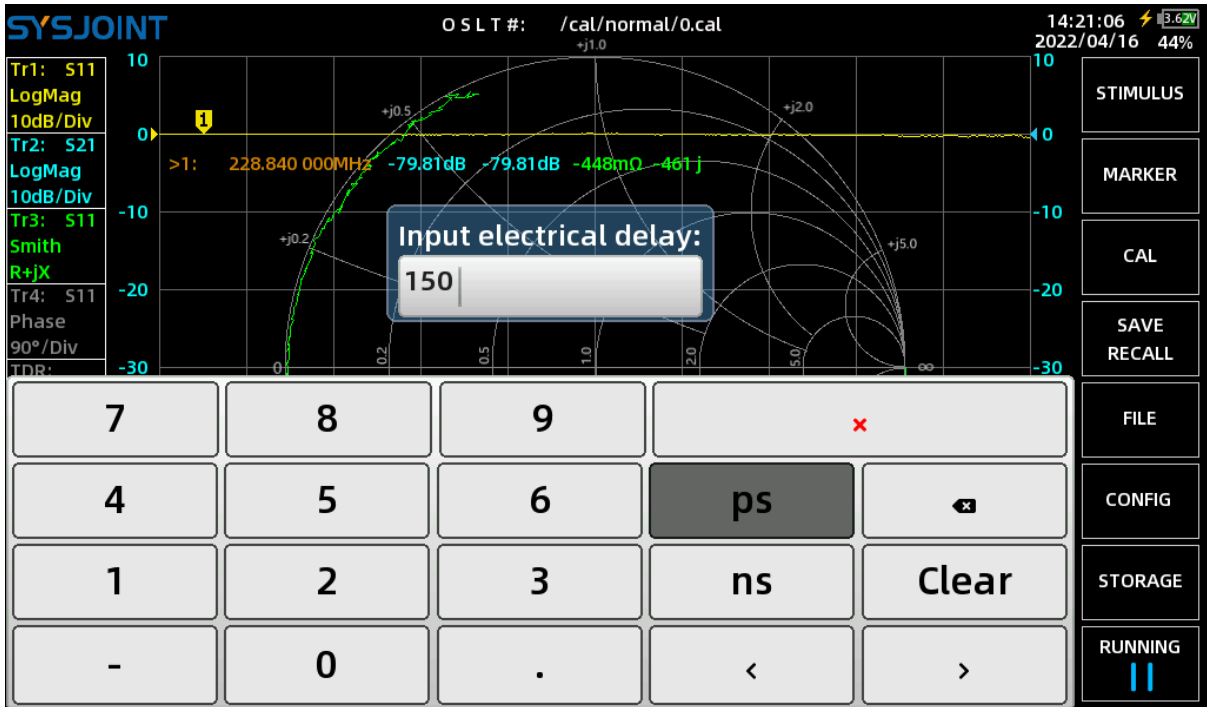

12 RF output power

RF output power of PORT1 is displayed here.
 Touch on this area to set the RF power: -42 ~ -12dBm.

13 Sweep points

Sweep points is displayed here.
 Touch on this area to set the scan points: 101 ~ 1001.

14 Average

Average times is displayed here.
 Touch on this area to set the average times: 1 ~ 25.

15 TDR info box

SV4401A can be used as a Time Domain Reflectometry (TDR), which is meaningful for S11 only.

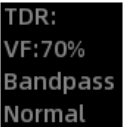
Touch on  to turn on TDR, then a brown TDR trace will appear on the screen.

Connect a cable to PORT1, keep the other end of the cable open or shorted, then move the marker to the peak of TDR trace, the estimated cable length will be reported on the screen.

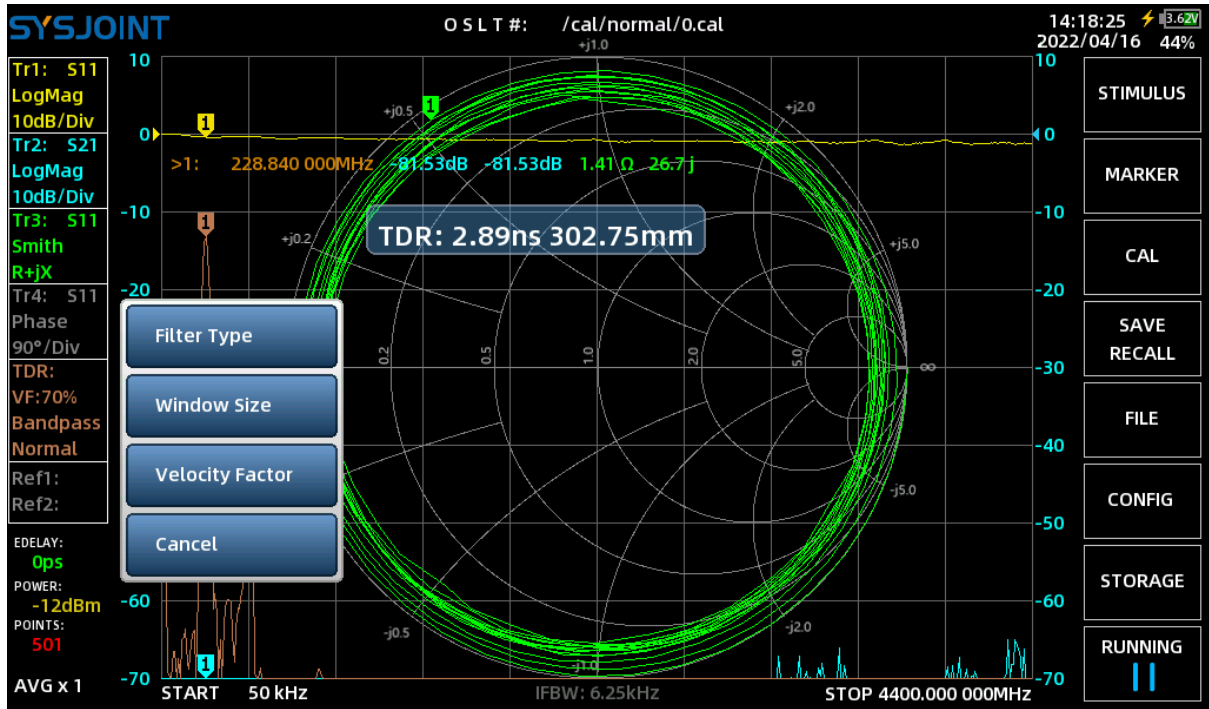

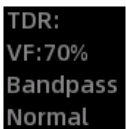
Long-press on  to call up the TDR setting menu.

[Filter Type] is used to specify the filter type of signal processing. There are 3 kinds of digital processing mode available: **[Low Pass Impulse]** , **[Low Pass Step]** , **[Bandpass]** , and the default setting is **bandpass**.

[Window Size] is used to specify the window size of signal processing. There three levels of window size: **[Max]** , **[Normal]** , **[Min]** , and the default setting is **normal**.

[Velocity Factor] is used to specify the velocity factor of the cable under test. Velocity factor is defined as the ratio of the electromagnetic wave speed in the transmission line to the electromagnetic wave speed in vacuum.

E.g., the typical velocity factor of RG405 cable is 70%, to get the length of a RG405 cable, you should touch on the area of **[Velocity Factor]** , then input 70 on the virtual keyboard and end up with ‘√’ .

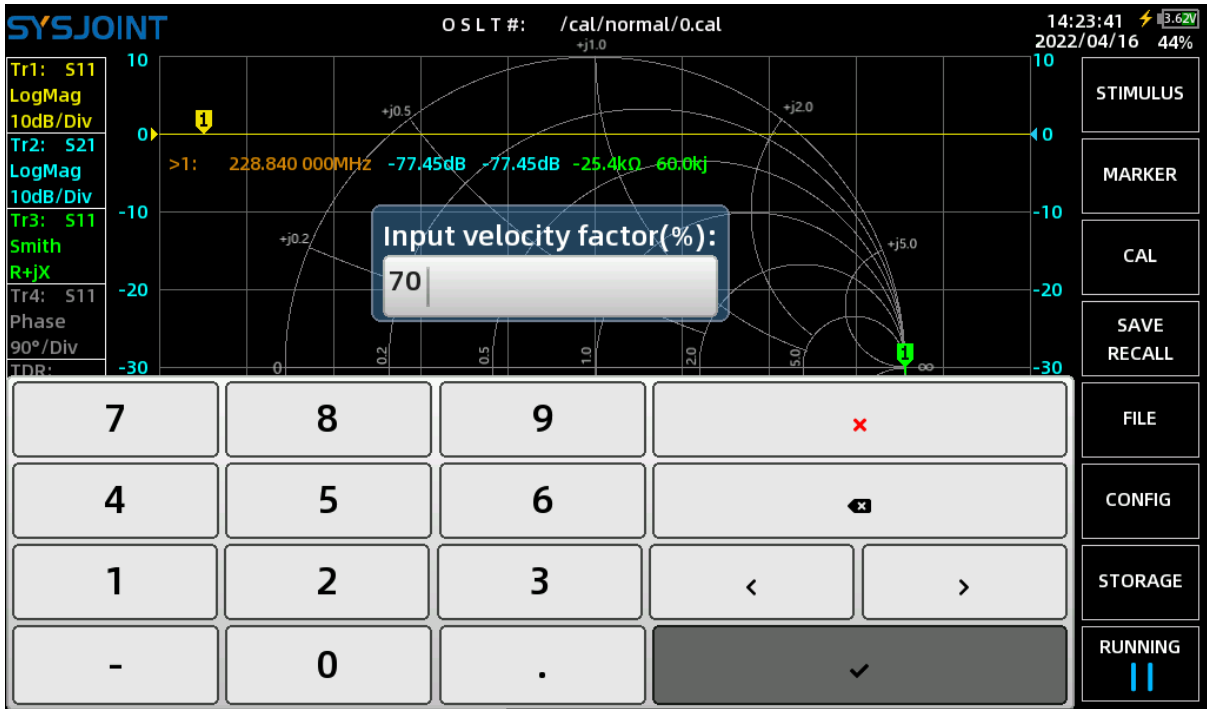

When using TDR, setting appropriate frequency range and sweep points will help us make the testing more efficiently.

The maximum cable length (L_{max}) that can be measured by TDR is determined by the following formula:

$$L_{max} = \frac{(N - 1)^2 \times C \times VF}{2 \times M \times SPAN}$$

Where N represents the sweep points, C represents the electromagnetic wave speed in vacuum, $M=1024$, VF is velocity factor, and $SPAN$ is the frequency span in Hz.

The time resolution of TDR trace (Δt) is determined by the following formula:

$$\Delta t = \frac{N - 1}{M \times SPAN}$$

⑩ Reference trace info box

Reference trace is very useful for production testing.

SV4401A supports up to 2 reference traces.

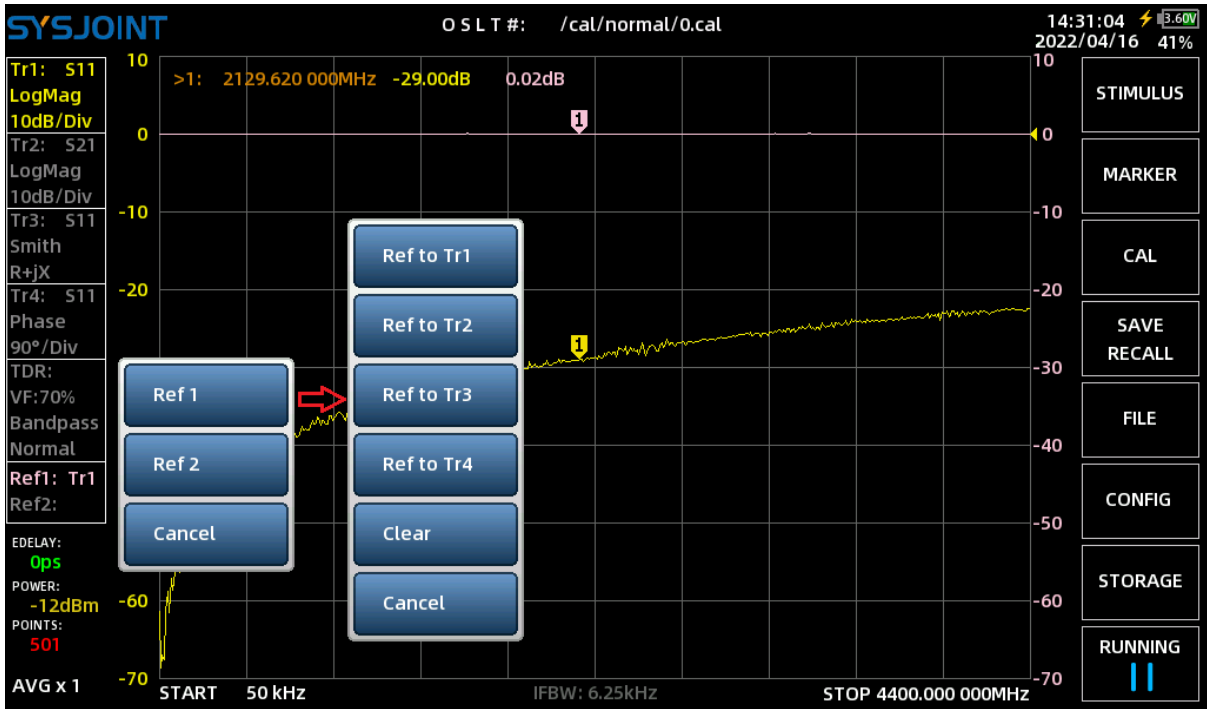

Take the picture above as an example: Long-press on **Ref1:** **Ref2:** to open the reference trace setting menu, then select **[Ref1]** → **[Ref to Tr1]** to set Tr1 as the reference trace, and a pink trace **Ref1** will appear. After doing this, trace Ref1 will keep holding, so you will be able to observe the difference between Tr1 and Ref1.

In order to observe the numerical difference between Tr1 and Ref1 conveniently, select **[MARKER]** → **[INFO SET]** from the main menu to open the marker table setting dialog, and make settings as shown below:

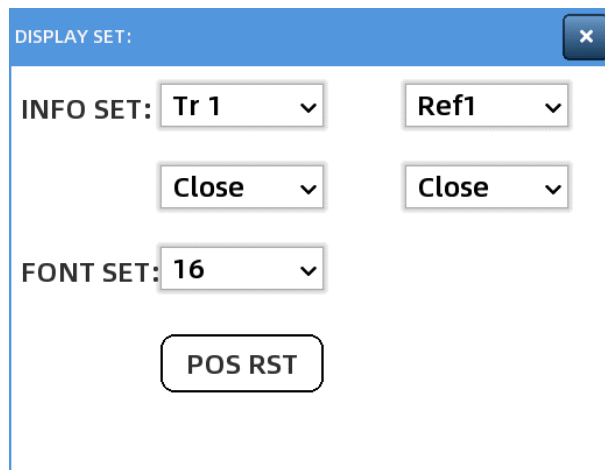

If you want to clear Ref1, please Long-press on **Ref1:** **Ref2:** to open the reference trace setting menu, then select **[Ref1]** → **[Clear]** .

It should be noted that the reference trace will be automatically cleared when SV4401A is powered off.

17 IFBW

The IF bandwidth is displayed here.

18 About

Touch on the logo **SYSJOINT** in the upper left corner of the screen to view the device information: model, frequency range, serial number, firmware version, etc.

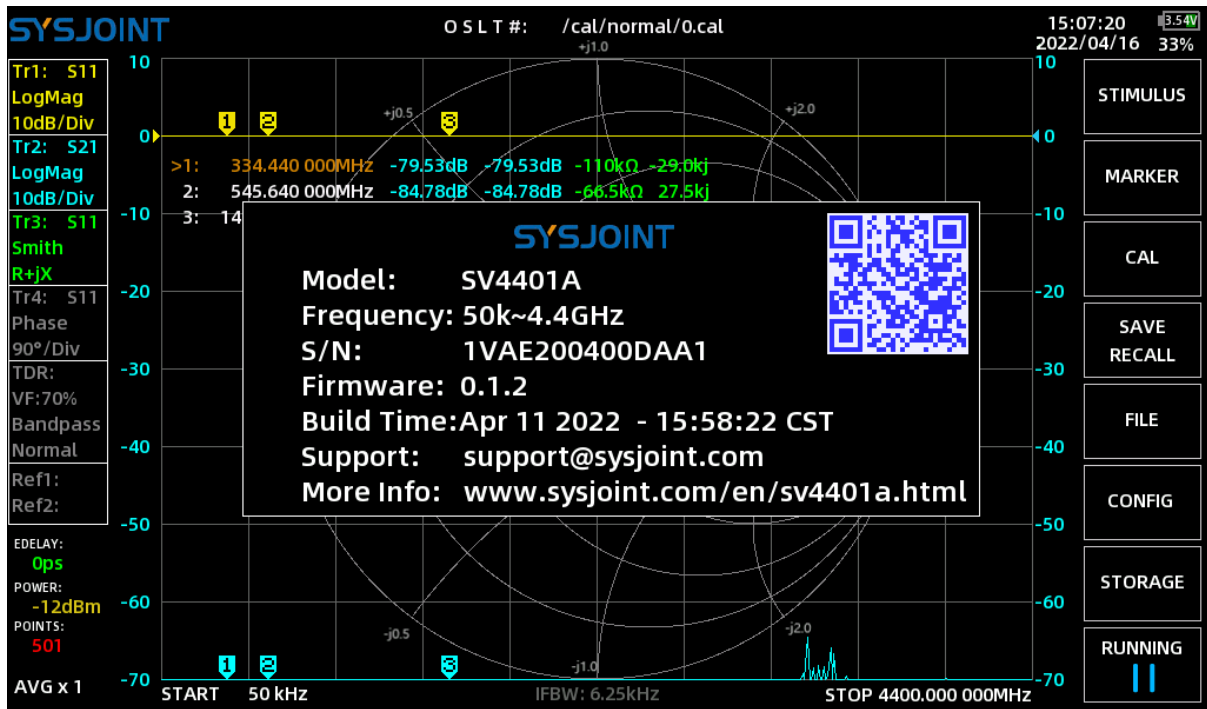

4. Menus

4.1. STIMULUS

[STIMULUS] menu contains menu items of [SET FREQUENCY], [L/C MATCH], [IFBW], [POWER], [AVG], [SWEEP POINTS].

4.1.1 SET FREQUENCY

SV4401A supports two sweep modes: non-single-frequency sweep and single-frequency sweep.

For non-single frequency sweep, the frequency range can be set in two ways:

- (1) Specify start and stop frequencies;
- (2) Specify center frequency and span.

For single-frequency sweep, you should specify the CW FREQ.

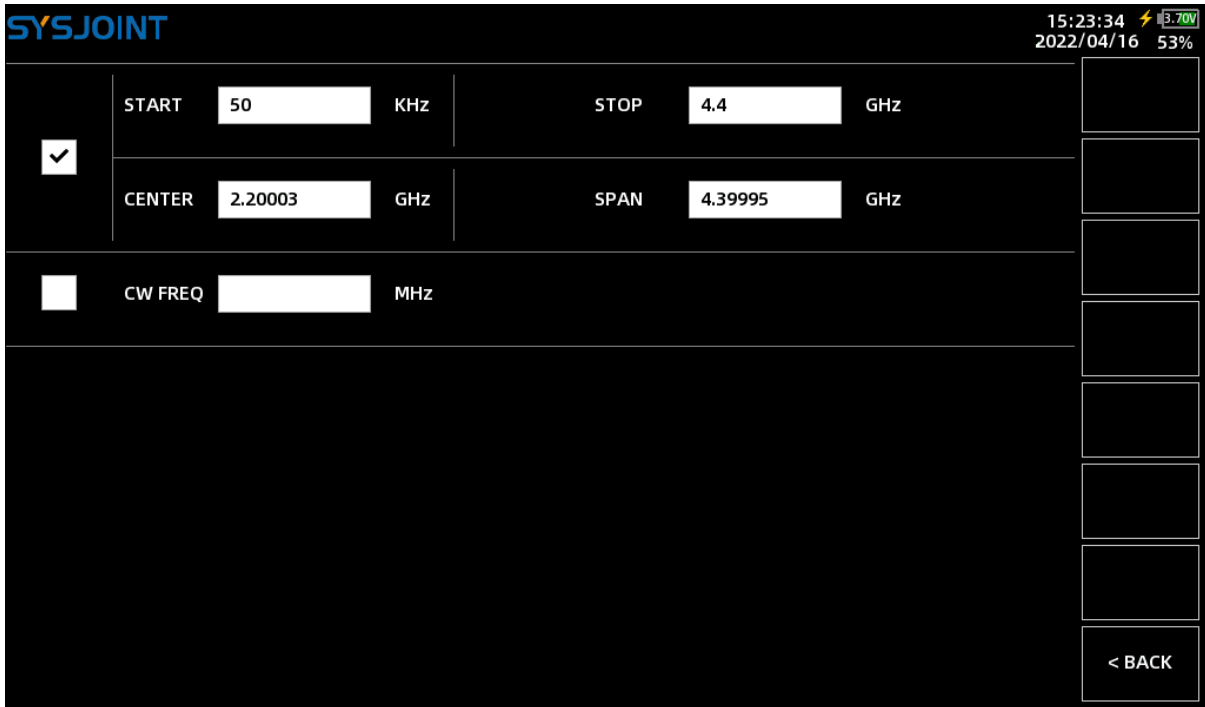

4.1.2 L/C MATCH

SV4401A supports automatic calculation of L/C matching parameters, matching the load impedance to the source impedance of 50 ohm.

The structure of the L/C matching network is shown in the following figure:

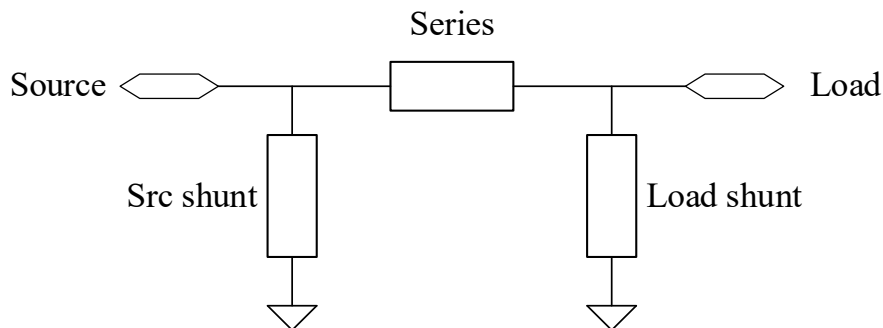

L/C matching example:

In the figure below, load impedance is 36.0-37.6j, and SV4401A automatically generates 4 matching methods:

- ① 4.58pF capacitor for source shunt and 22.0nH inductor in series;
- ② 29.4nH inductor for source shunt and 5.56nH inductor in series;
- ③ 82.6nH inductor for load shunt and 13.0nH inductor in series;
- ④ 15.7nH inductor for load shunt and 10.3pF capacitor in series.

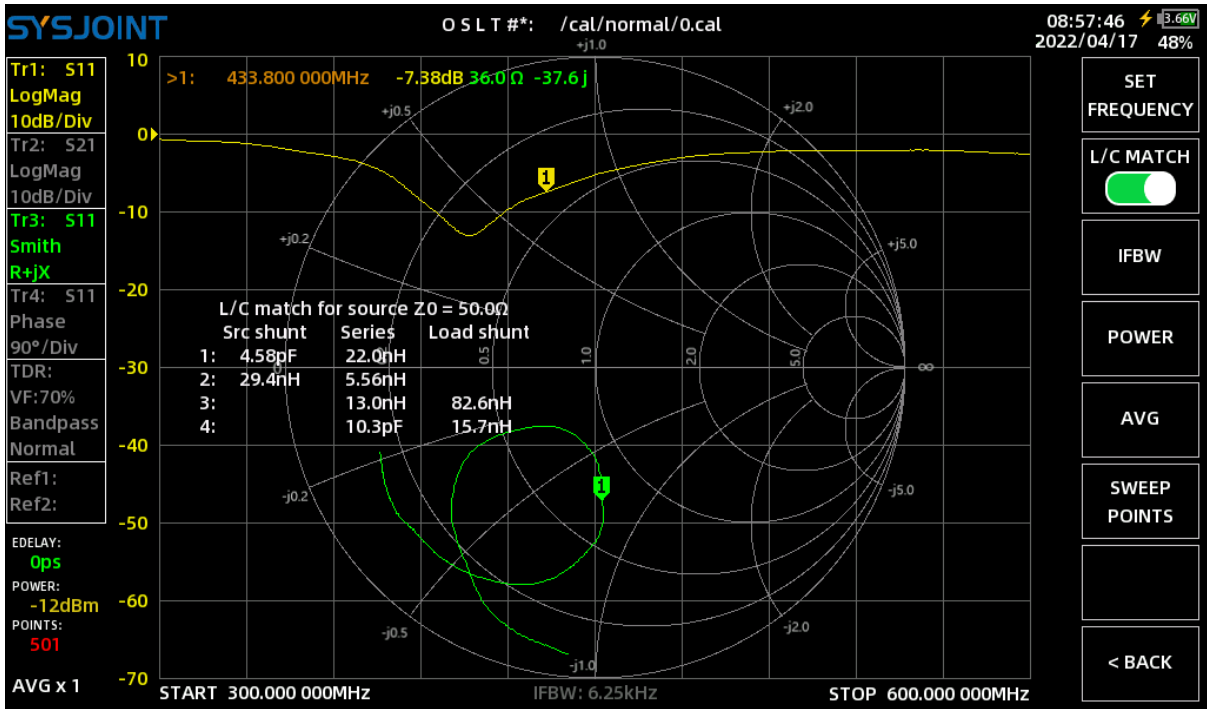

4.1.3 IFBW

IFBW refers to the bandwidth of the IF filter of the receiver inside the VNA. A wider IF bandwidth will increase the sweep speed of the VNA, but causes more noise to enter the receiver inside the VNA, which will reduce dynamic range.

Reducing the IFBW will improve dynamic range, while the sweep speed drops.

The default IFBW is 12.5kHz, which can be set to 12.5kHz, 6.25kHz, 3.12kHz, 1kHz, 300Hz, 100Hz, and 30Hz by selecting **[STIMULUS]** → **[IFBW]** from the main menu.

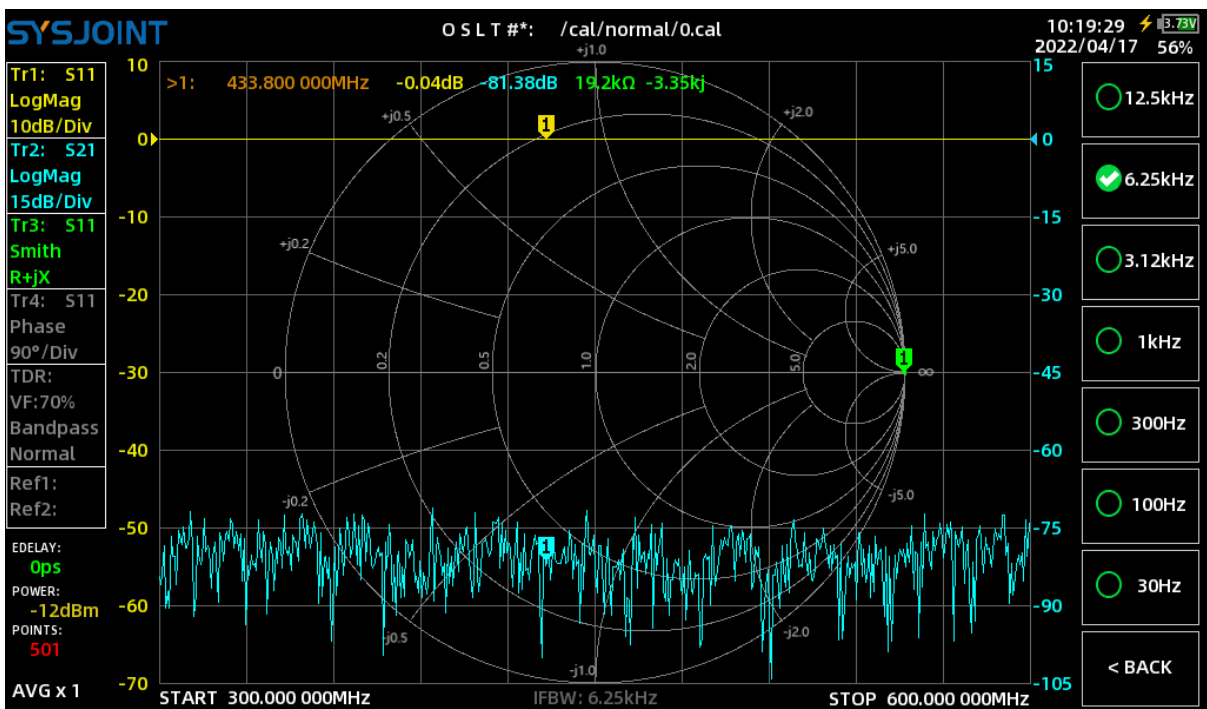

4.1.4 POWER

The RF output power of the SV4401A is adjustable from -42dBm to -12dBm. A lower RF output power is suitable for testing the input impedance of the amplifier.

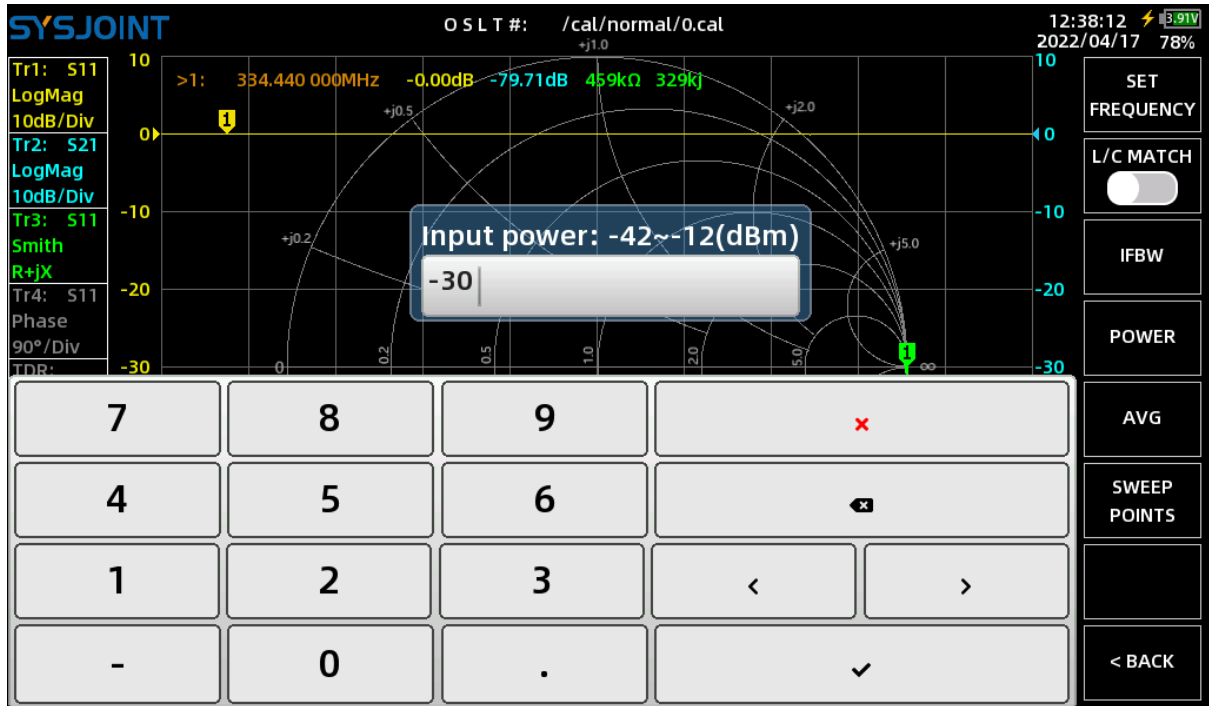

4.1.5 AVG

SV4401A supports data averaging to smooth trace noise, average times: 1 ~ 25.

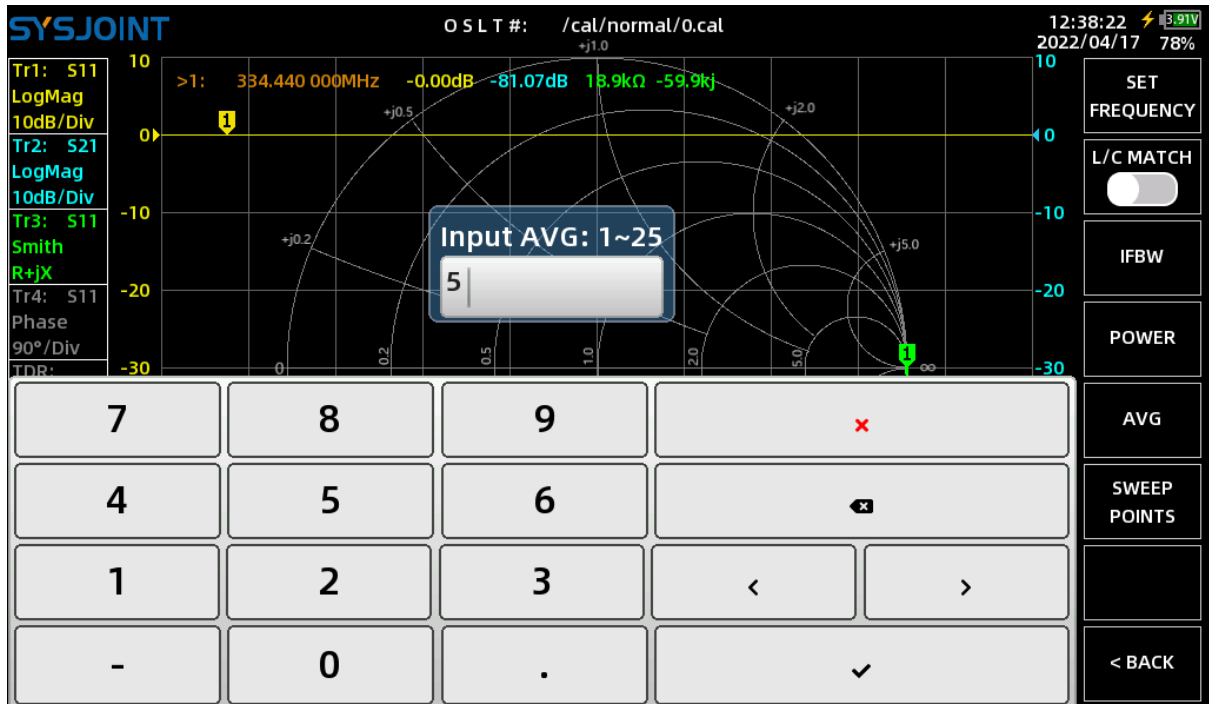

When the averaging factor is set, a data collection progress bar will appear.

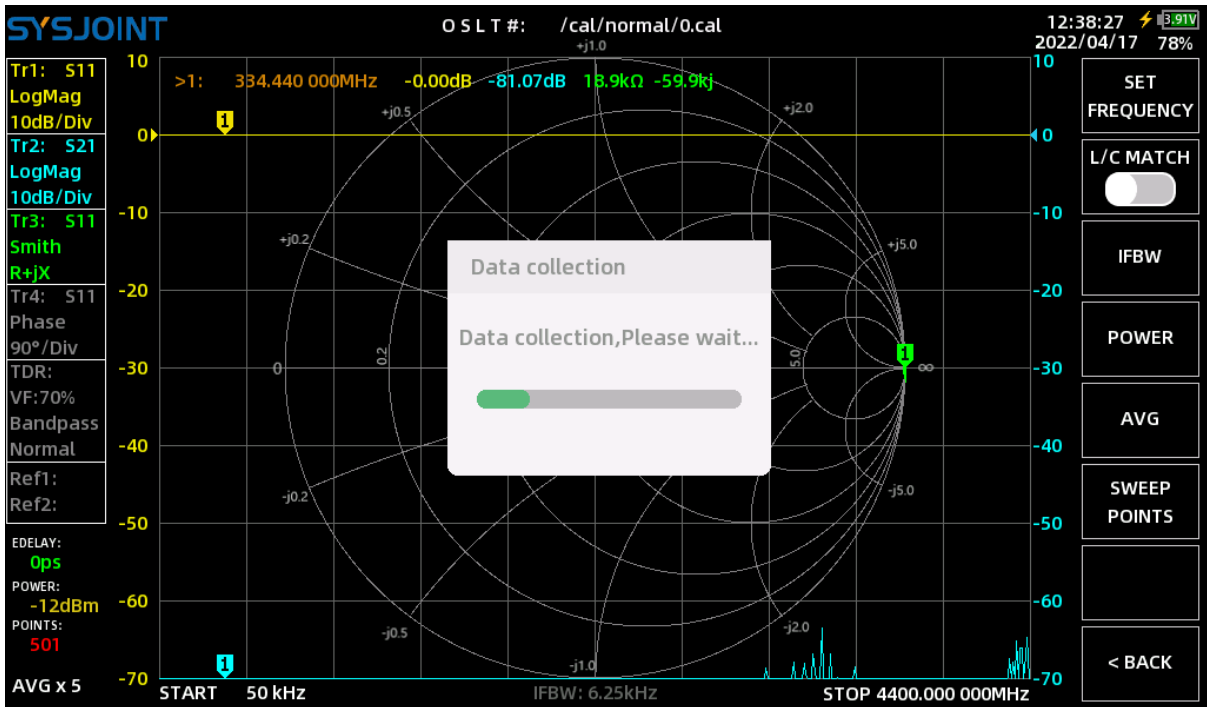

4.1.6 SWEEP POINTS

The sweep points can be set from 101 to 1001.

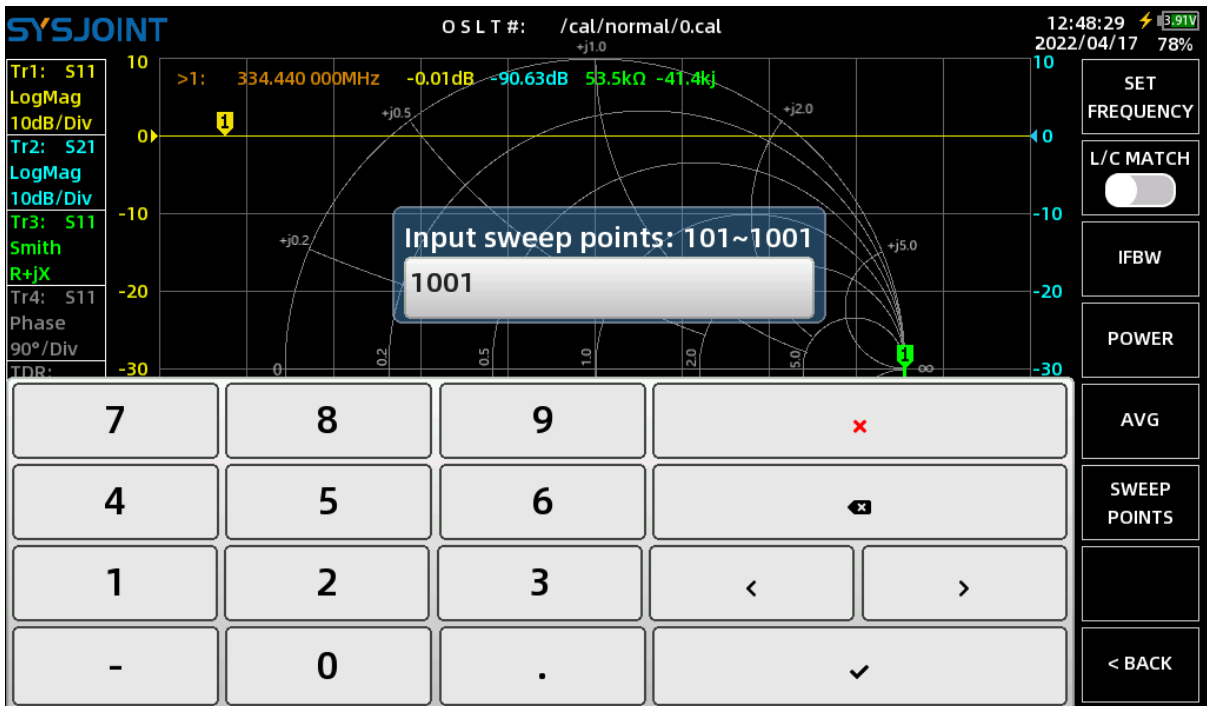

4.2. MARKER

[MARKER] menu contains menu items of **[SELECT MARKER]** , **[SEARCH]** , **[INFO SET]** , **[DRAG ON]** .

4.2.1 SELECT MARKER

[SELECT MARKER] menu contains menu items of **[MARKER 1]** , **[MARKER 2]** , **[MARKER 3]** , **[MARKER 4]** , **[MORE]** , **[ALL OFF]** .

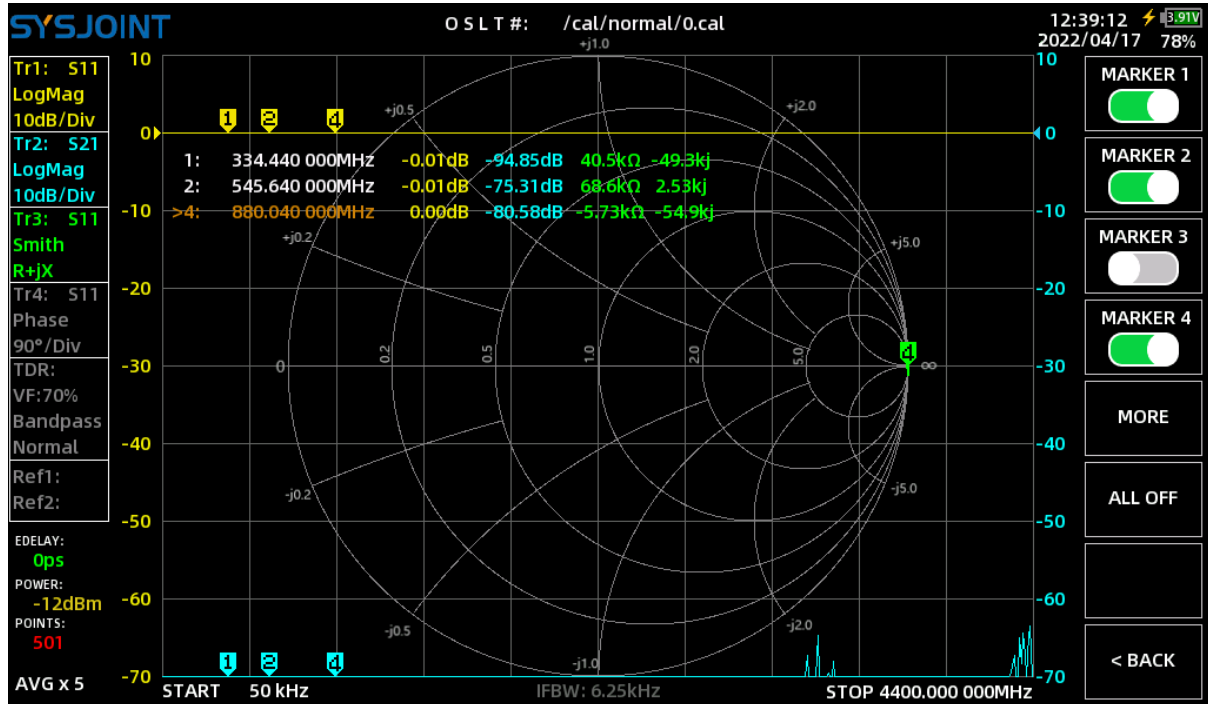

[MARKER n] is used to turn on, turn off or activate a marker. If a marker is turned off (take marker 3 in the above figure as an example), touch on **[MARKER 3]** will turn on marker 3, and a '>' symbol will appear ahead marker 3 on the marker table, indicating that marker 3 is activated. Touch on **[MARKER 3]** again will turn off marker 3.

Touch on the menu item corresponding to a turned-on marker will activated the marker. Take the above figure as an example, marker 4 is the active marker, when you touch on **[MARKER 1]** the '>' symbol will move to the first row of the marker table, indicating that marker 1 Indicates that marker 1 has become the active marker.

[ALL OFF] is used to turn off all the markers at a time.

4.2.2 SEARCH

On the **[SEARCH]** page, you will be able to configure the tracking method of each marker individually. Keep in mind that you should check the box in front of the cell to enable tracking.

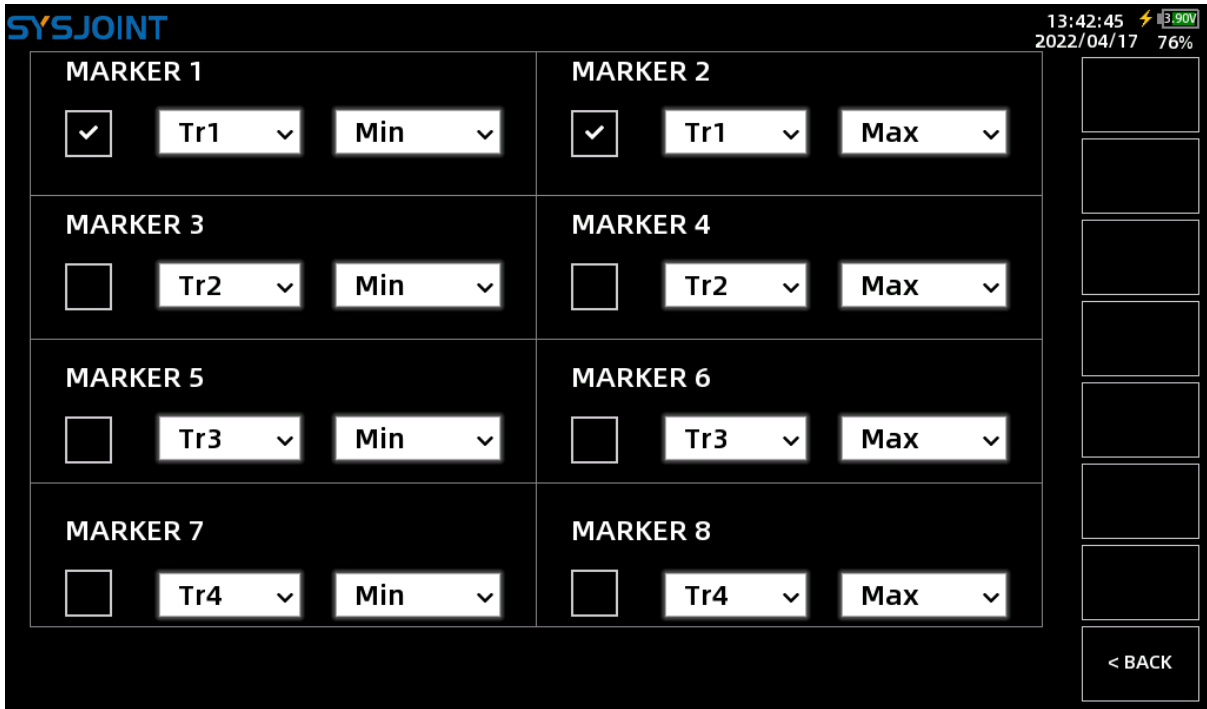

4.2.3 INFO SET

Touch on **[INFO SET]** to call up the 'DISPLAY SET' dialog. There are settings of **[INFO SET]** , **[FONT SET]** , and **[POS RST]** in the dialog.

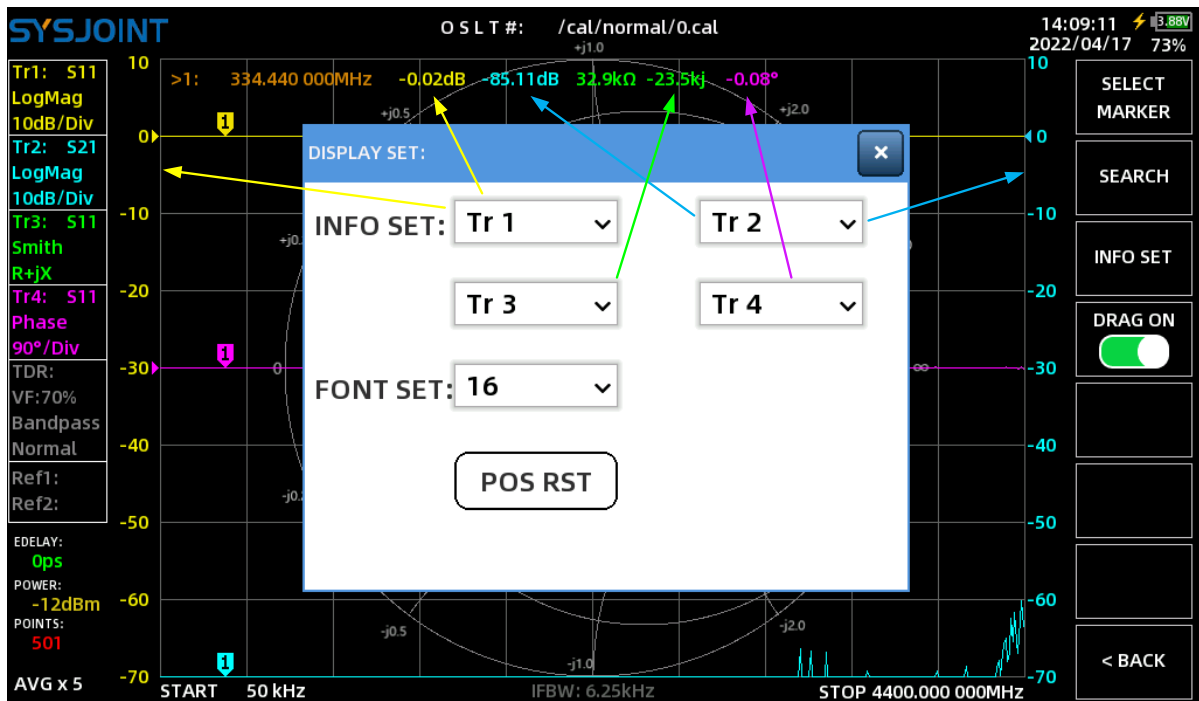

[INFO SET] is used to set which of the traces data will be displayed on the marker table, available options are Tr1, Tr2, Tr3, Tr4, Ref1, Ref2, and close.

Take the above figure as an example, the left ordinate corresponds to the scale of Tr1, and the

right ordinate corresponds to the scale of Tr2. The marker table shows the values of Tr1, Tr2, Tr3, and Tr4, corresponding to the settings in the 'DISPLAY SET' dialog.

[FONT SET] is used to set the font size of marker table, available font sizes are 16, 18, 20, and 24.

When the marker table is accidentally dragged to the edge of the screen and not able to be dragged back, you can touch on **[POS RST]** to make it return to the original position.

4.2.4 DRAG ON

[DRAG ON] is used to enable/disable the draggable attribute of the marker.

4.3. CAL

[CAL] menu contains menu items of **[CALIBRATE]** , **[RESET]** .

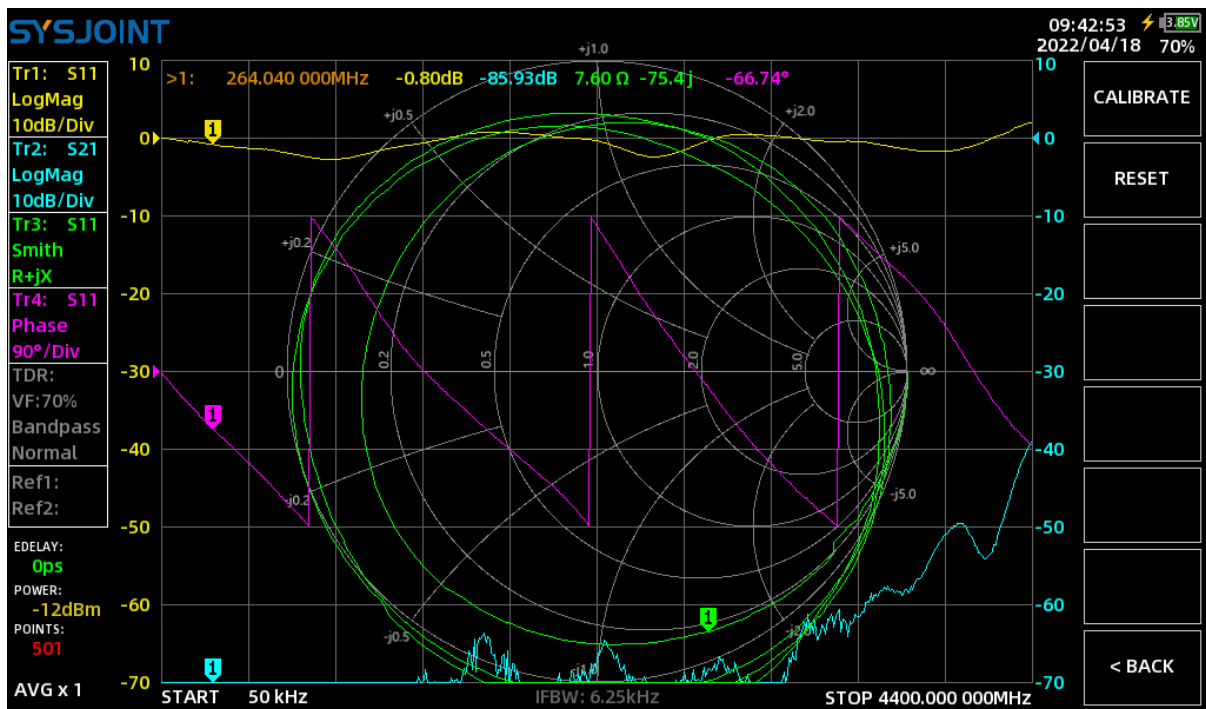

4.3.1 RESET

Touch on **[RESET]** will clear the calibration status in the RAM, and the calibration status indicators 'OSLT#*' will also disappear, but the calibration status stored in the memory card will not be deleted, and they will be recalled by selecting **[SAVE/RECALL]** → **[RECALL]** → **[RECALL n]** from the main menu.

4.3.2 CALIBRATE

[CALIBRATE] is used for calibration.

The following accessories should be prepared before calibration:

- (1) N to SMA adapters;
- (2) SMA OPEN calibration piece;
- (3) SMA SHORT calibration piece;
- (4) SMA LOAD calibration piece;
- (5) SMA-JJ coaxial cable;
- (6) SMA-KK adapter (optional).

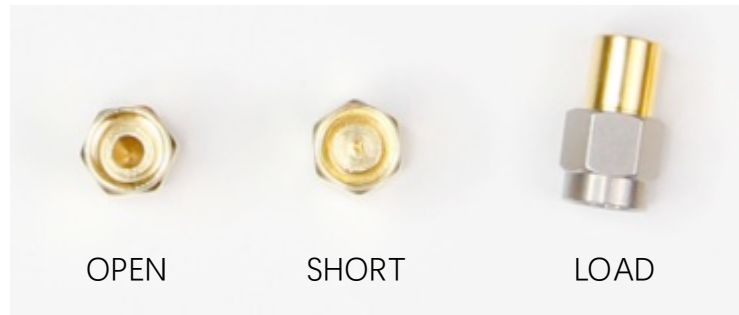

Firstly, you need to set an appropriate frequency range, see section [4.1.1](#) for detail.

Touch on **[CALIBRATE]** to enter the calibration menu, and perform the calibration according to the following steps:

Step ①

Connect N to SMA adapters to PORT1 and PORT2, then connect the OPEN calibration piece to PORT1 or the end of the cable connected to PORT1, as shown in the figure below.

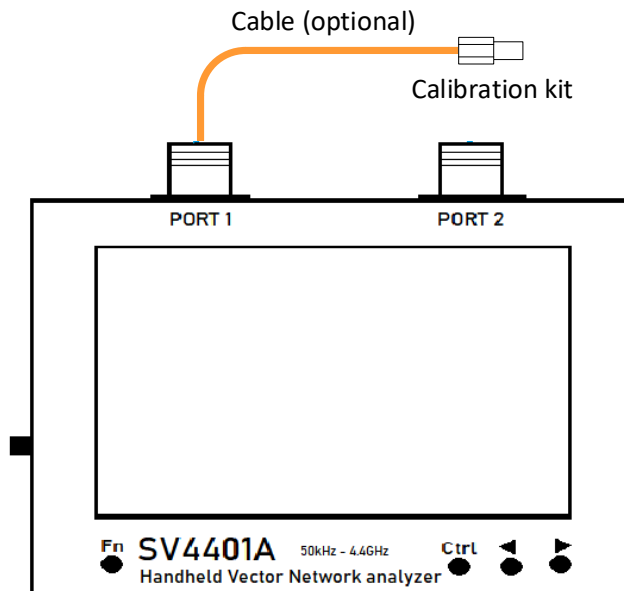

Touch on **[OPEN]** to perform OPEN calibration. After the open calibration is completed, a '✓' sign will appear on the **[OPEN]** menu item, and the letter 'O' will appear on the upper part of the screen at the same time, indicating that the device has been performed the open calibration.

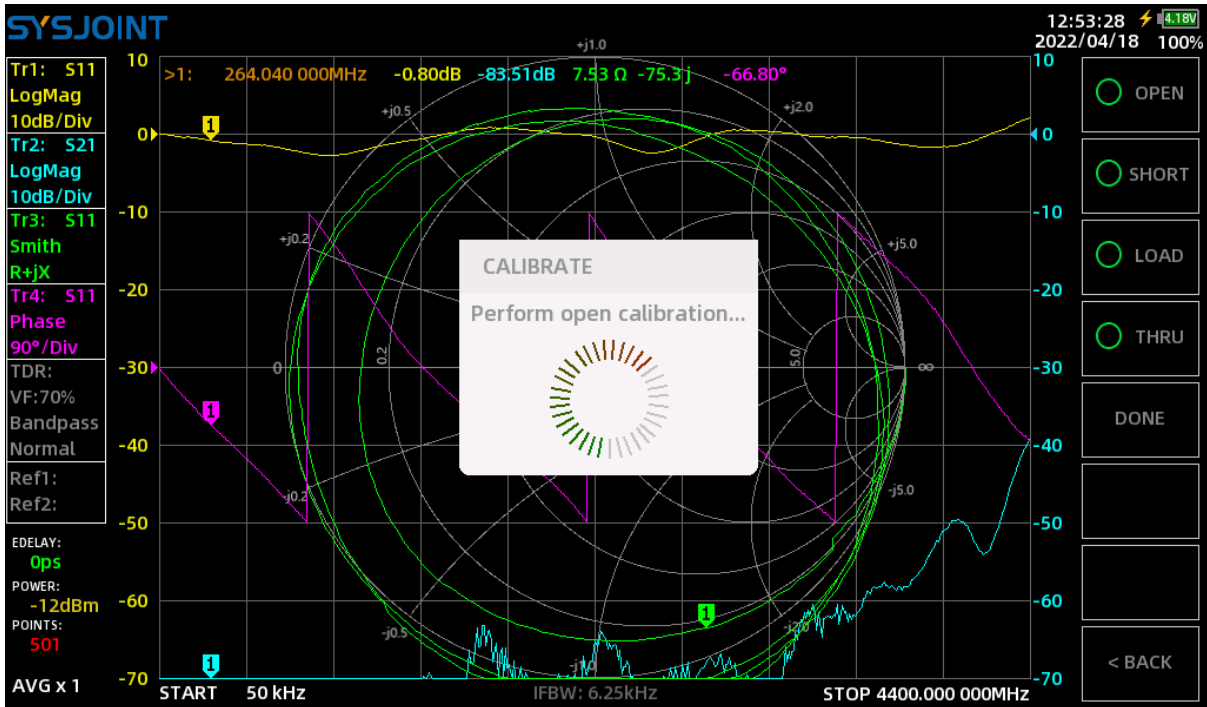

NOTE: We usually need to connect the DUT to VNA with cables, in this time, the cable becomes a part of the measuring system, and the end of the cable becomes the VNA port.

Step ②

Connect the SHORT calibration piece to PORT1 or the end of the cable connected to PORT1, then touch on **[SHORT]** to perform the short calibration.

Step ③

Connect the LOAD calibration piece to PORT1 or the end of the cable connected to PORT1, then touch on **[LOAD]** to perform the load calibration.

Step ④

Connect PORT1 and PORT2 with cable and adapter (optional), as shown in the figure below, then touch on **[THROUGH]** to perform the through calibration.

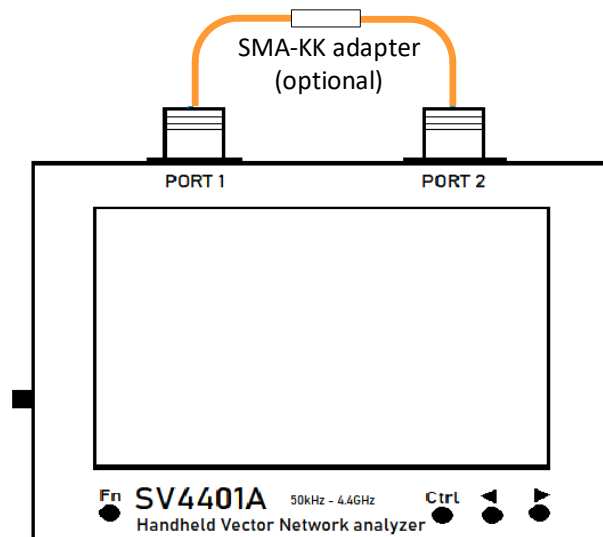

Step ⑤

Touch on **[DONE]**, the string '**OSLT #***' will appear on the upper part of the screen, indicating that the calibration state has been generated but not yet saved. Touch on **[SAVE n]** to save the calibration state, and the frequency range of the calibration state will be display on the menu item. You can also touch on **[SAVE FILE]** to save the calibration state into a file with a custom file name.

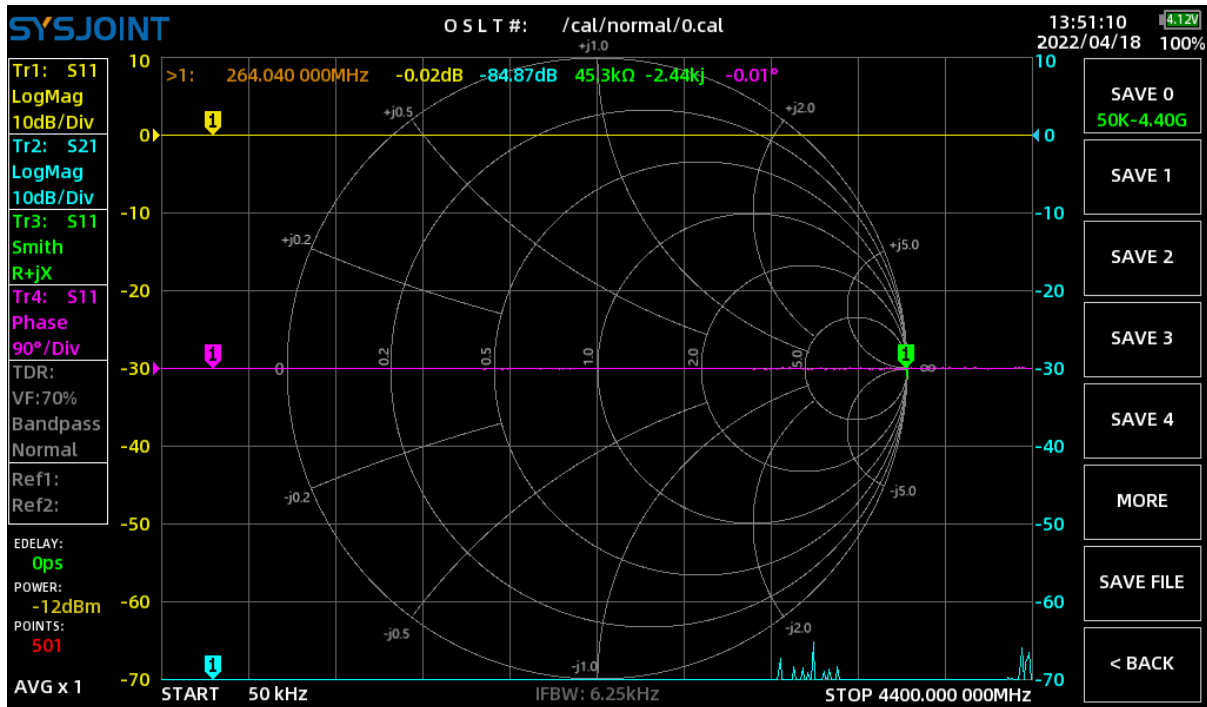

When properly calibrated, the VNA should have the following characteristics:

(1) When PORT1 is open-circuited, the S11 Smith trace converges on the far-right side of the Smith chart, the value of S11 LOGMAG is near 0dB, for S21 LOGMAG trace, the lower the better.

(2) When PORT1 is short-circuited, the S11 Smith trace converges on the far-left side of the Smith chart, the value of S11 LOGMAG is near 0dB, for S21 LOGMAG trace, the lower the better.

(3) When PORT1 is connected to a 50-ohm load, the S11 Smith traces converge at the center of the Smith chart. For S11 and S21 LOGMAG trace, the lower the better.

(4) When PORT1 and PORT2 are directly connected with a RF cable, the S11 Smith trace is near the center of the Smith chart, and the S21 LOGMAG value is near 0dB. For S11 LOGMAG trace, the lower the better.

4.4. SAVE/RECALL

[SAVE/RECALL] contains menu items of **[RECALL]** and **[SAVE]** .

4.4.1 RECALL

Touch on **[RECALL n]** to recall calibration state from slot n.

Touch on **[RECALL FILE]** to call up the 'Recall from file' dialog, and choose a .cal file to recall the corresponding calibration state. The user named calibration files are under the path of ./cal.

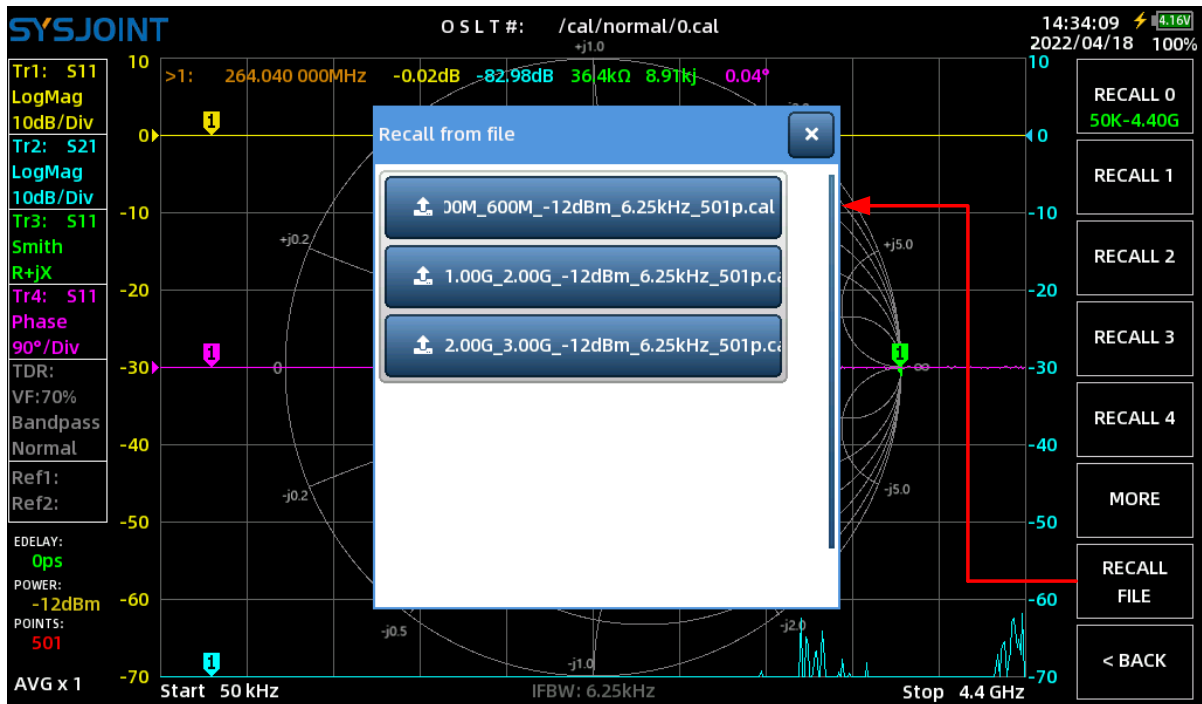

4.4.2 SAVE

Touch on **[SAVE n]** to save the calibration state, and the frequency range of the calibration state will be display on the menu item.

You can also touch on **[SAVE FILE]** to save the calibration state as a file with a custom file name. The automatically generated file name is a string containing information of start and stop frequencies, RF output power, IF bandwidth, and sweep points. You can modify the filename by the virtual keyboard.

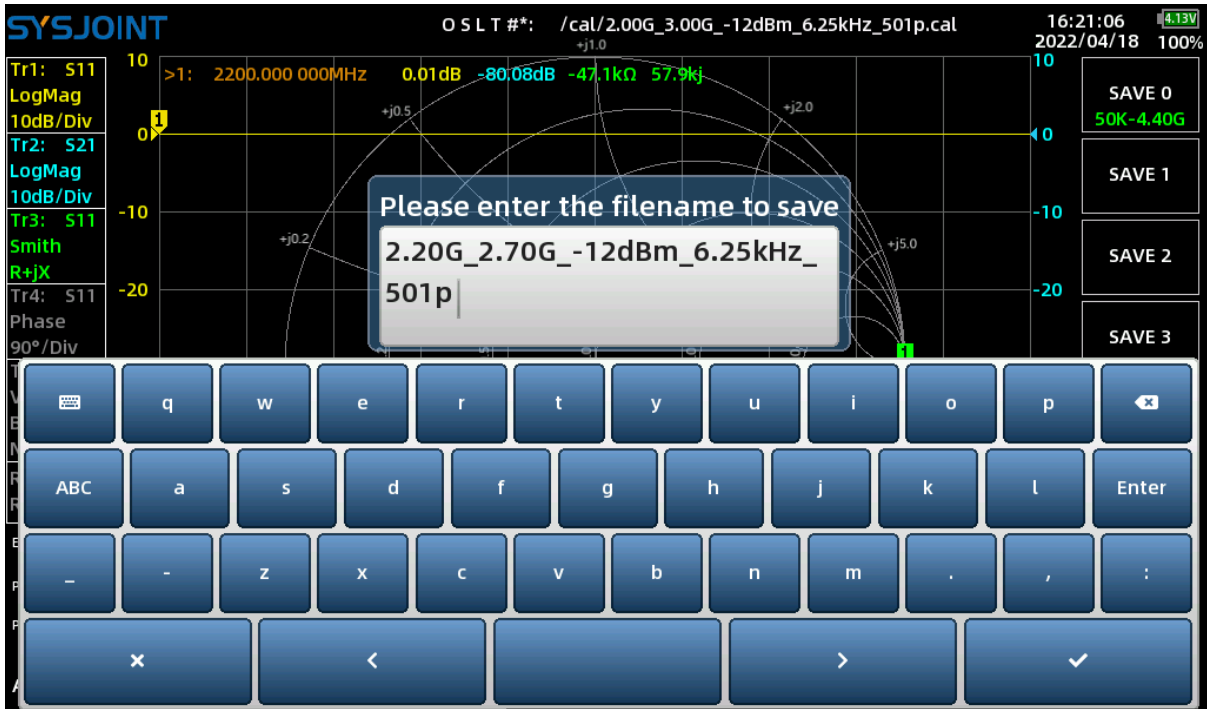

4.5. FILE

Touch on **[FILE]** to enter the file management interface.

You will be able to access files on the SV4401A and do file browsing, searching, copying, pasting, renaming, deleting, etc.

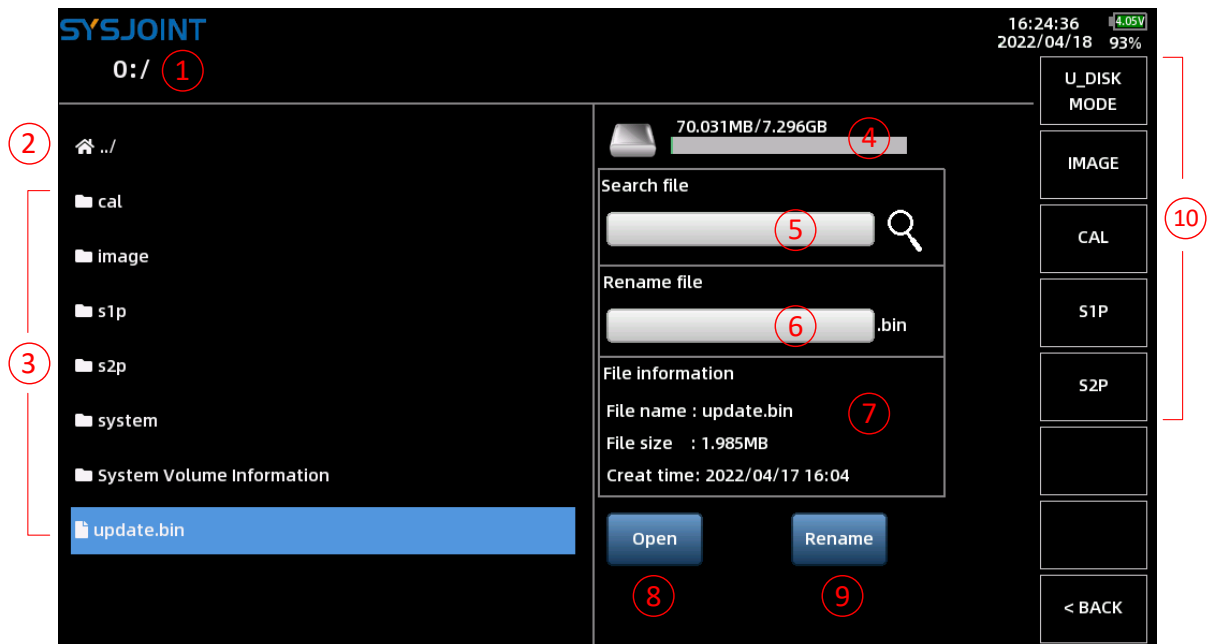

① File path

The current path is displayed here.

② Home icon

Touch on the home icon (🏠) to return to the parent directory. If the current path is the root directory, touching on the home icon will refresh the directory.

Long-press on the home icon will call up the quick menu of **【Paste】** , **【New folder】** and **【Remount】** .

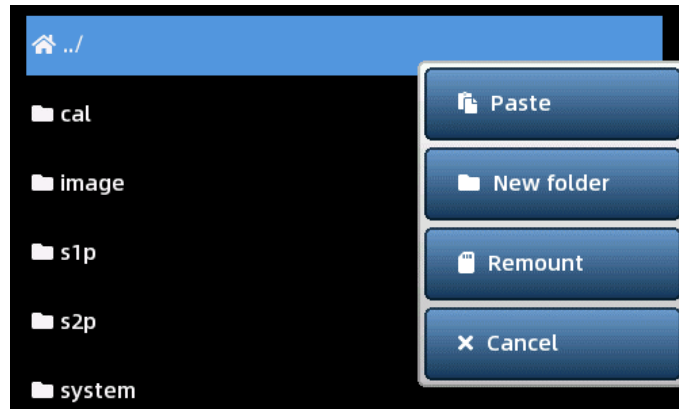

Touch on **【Paste】** to paste the copied file or folder to the root directory. This menu item will not appear if the user has no copy or cut operations before.

Touch on **【New folder】** to create a new folder under the root directory.

Touch on **【Remount】** to remount the memory card when file access error occurs.

③ File list

Touch on a folder will enter the sub-directory of the folder. Touch on a file will select the file, and you will be able to view the file information on the right side, and you can also open or rename the selected file.

Long-press on a file or folder will call up the quick menu of **【Copy】** , **【Cut】** and **【Delete】** .

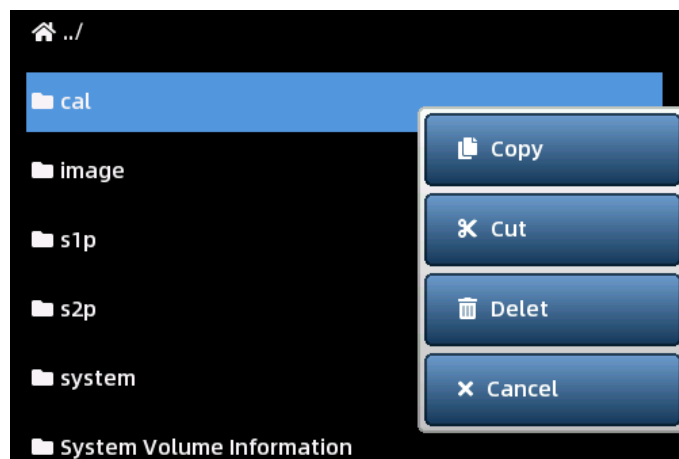

Touch on **【Copy】** , then enter the target directory and Long-press the home icon, select **【Paste】** to copy the file or folder to the target directory.

Touch on **【Cut】** , then enter the target directory and Long-press the home icon, select **【Paste】**

to move the file or folder to the target directory.

[Delete] is used to delete a file or folder. A confirmation dialog will appear when deleting a file or folder. Select 'OK' to confirm the deletion, select 'CANCEL' to cancel the deletion.

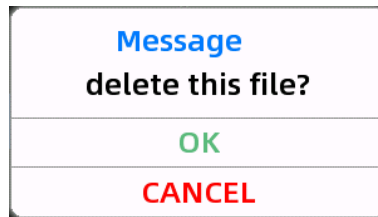

④ Memory card usage

The usage of the internal memory card is displayed here.

⑤ Search file

Touch on the search bar to enter keywords, then touch the magnifying glass icon to launch searching. The search results will list all files that contain the keywords under the current directory.

⑥ Rename file

To rename a file, please select a file firstly, then touch on the rename bar to enter the new filename, then touch on **[Rename]** button to execute renaming.

For renaming a folder, please firstly Long-press on the folder to call up the quick menu, then select **[Cancel]**, and the folder will become selected. After doing this, you can enter the new name and execute renaming.

⑦ File information

The file name, size and creation time of the currently selected file will be displayed here.

⑧ Execution button

Touch on **[Open]** to open the selected file (only valid calibration files or screenshots can be opened).

Touch on **[Rename]** to rename the selected file or folder.

⑨ Quick menu

[U_DISK MODE] : Connect SV4401A to your Windows PC with the USB Type-C cable, then touch on **[U_DISK MODE]**, a new disk will appear on your PC, and you will be able to access the files in the SV4401A memory card on the PC. Pay attention that screenshotting is not available under U-disk mode.

[IMAGE] is used to search all screenshots in the memory card.

[CAL] is used to search all the .cal files in the memory card.

[S1P] is used to search all the .s1p files in the memory card.

[S2P] is used to search all the .s2p files in the memory card.

Note: If there is lot of files, the search time will be longer.

4.6. CONFIG

There are 4 configuration items on the settings page: **LANGUAGE**, **SLEEP TIME**, **TIME**, and **BKLIGHT**.

LANGUAGE: The language is fixed in English and not configurable.

SLEEP TIME: When the user does not operate SV4401A for a specific period, SV4401A will automatically enter sleep mode to save power. The auto-sleep interval can be set to 10 minutes, 20 minutes, 30 minutes, 40 minutes, or never.

TIME: User can set the year, month, and date through the calendar, set the hour and minute through the virtual wheel, and touch on the **[SETTING]** button to complete the setting.

BKLIGHT: Slide to adjust the backlight brightness.

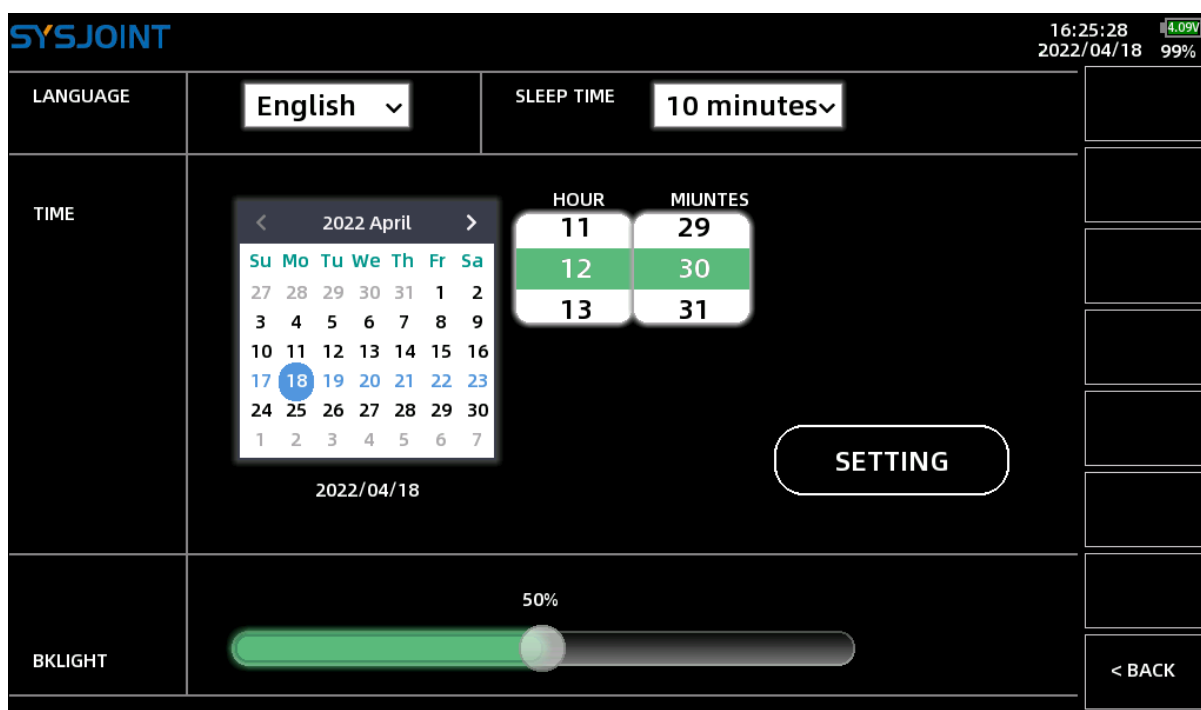

4.7. STORAGE

[STORAGE] menu contains menu items of **[SAVE S1P]** , **[SAVE S2P]** .

4.7.1 SAVE S1P

Touch on **[SAVE S1P]** to save the s-parameter data to S1P file, and the file can be exported to PC through the USB Type-C port.

4.7.2 SAVE S2P

Touch on **[SAVE S2P]** to save the s-parameter data to S2P file.

4.8. RUN/PAUSE

Touch to pause sweeping, touch again to resume sweeping.

5. Physical buttons

SV4401A has 4 physical buttons, which can be used for shortcut operations by single-click, double-click, long-press, and key combination.

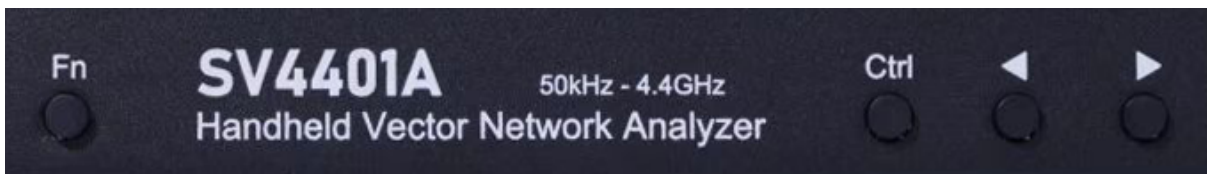

5.1. screenshot

Press and hold the **Fn** button, and then click the **Ctrl** button to take a screenshot. Screenshots are named with the time by default and are automatically saved under the path of **/image**.

5.2. Specify marker frequency

Long-press the **Ctrl** button to call up the keyboard. After entering the frequency value, the active marker will move directly to the specified frequency point.

5.3. Add marker

Double click **Ctrl** button to quickly add a new marker, and the new marker is active.

5.4. Delete marker

Double click **Fn** button to quickly delete the active marker.

5.5. Switch marker

Press and hold the **Fn** button, and then click the ◀ button to inactivate the current marker and activate the marker in front.

Press and hold the **Fn** button, and then click the ▶ button to inactivate the current marker and activate the marker behind.

6. User defined information

SV4401A supports displaying user-defined information on the boot screen. The setting method is as follows:

1. Create a text file named 'user_info.txt' on PC;
2. Open 'user_info.txt' and input the string which you want to be displayed on the boot screen (printable ASCII characters only, e.g., support@sysjoint.com). The maximum string length is 50;
3. Connect SV4401A to PC and enter U-disk mode, then copy 'user_info.txt' to the root directory of the U-disk;
4. Restart SV4401A.

7. PC software

PC software download: <http://www.sysjoint.com/file/Nanovna-Saver-0.3.10-by-SYSJOINT.exe>

For Win10 system, there is no need to install the driver.

For Win7 system, please install the driver:

http://www.sysjoint.com/file/sv4401a_usb_cdc_driver.rar

Note: PC software provided by SYSJOINT only supports Windows system, Linux or MacOS version of the PC software is available from: https://github.com/sysjoint-tek/NanoVNA-Saver-0.3.10-by_SYSJOINT

Connect SV4401A to PC with the USB Type-C cable, as shown below:

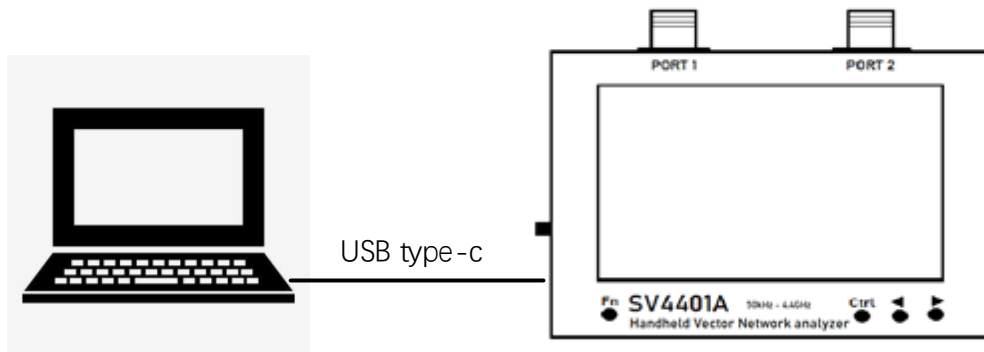

Double click 'Nanovna-saver-0.3.10-by_SYSJOINT.exe' to run the PC software, and select the correct COM port. If there is no COM port detected, please click **[Rescan]**.

After selecting the correct COM port, click **[connect to device]** to establish the communication connection between SV4401A and the PC.

With PC software, you can set the start and stop frequency, get the measurement results, set markers, etc.

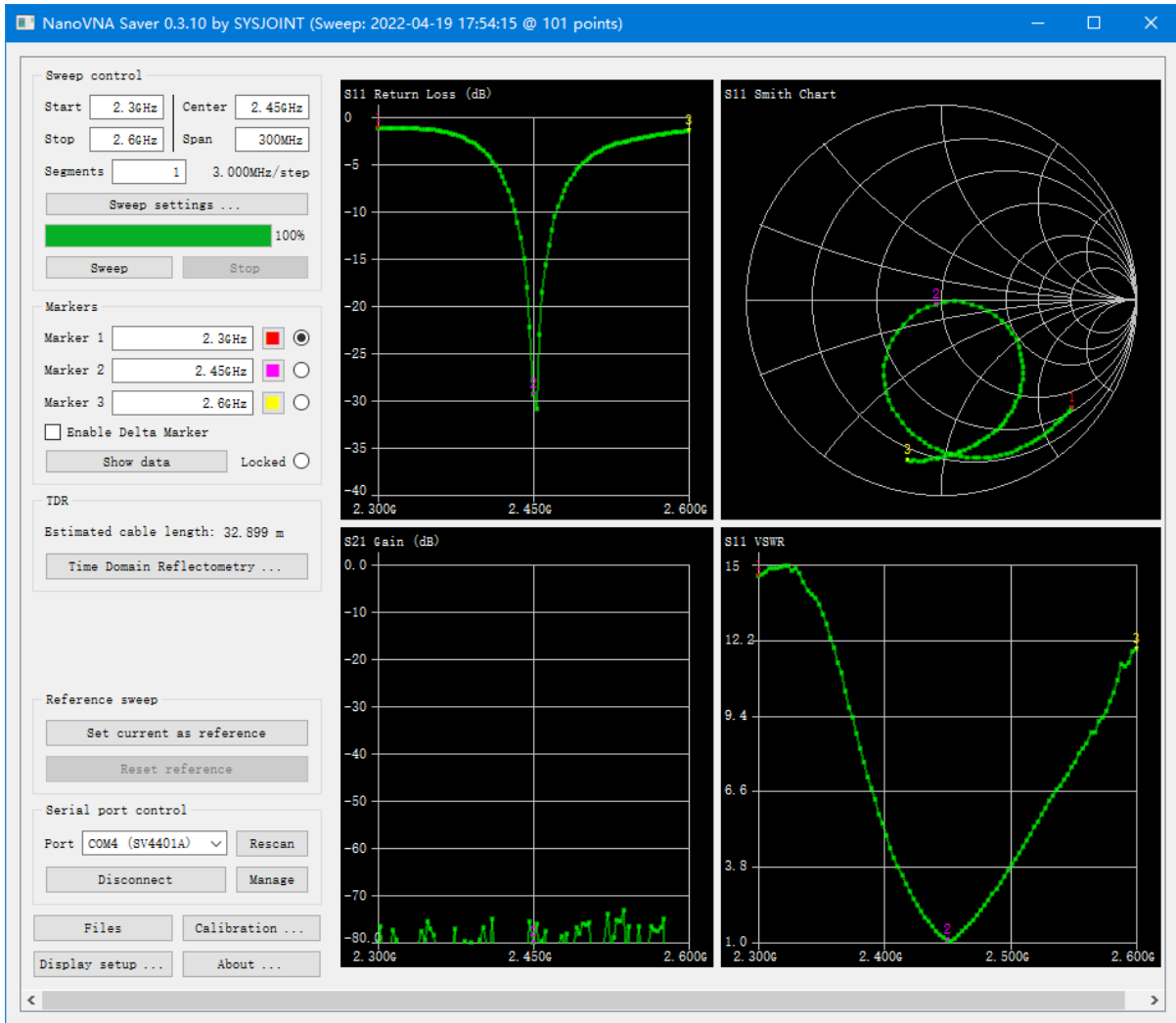

8. Console Command

SV4401A supports character console commands, you can interact with the device through serial tools.

It is also possible to design a customized PC software according to the commands.

8.1. Get serial port number

Connect SV4401A to PC, right-click on 'This PC', select 'Manage' to call up 'Computer management' dialog, click 'Device Manager' and then click 'Ports (COM & LPT)', you will find the serial port number as shown below.

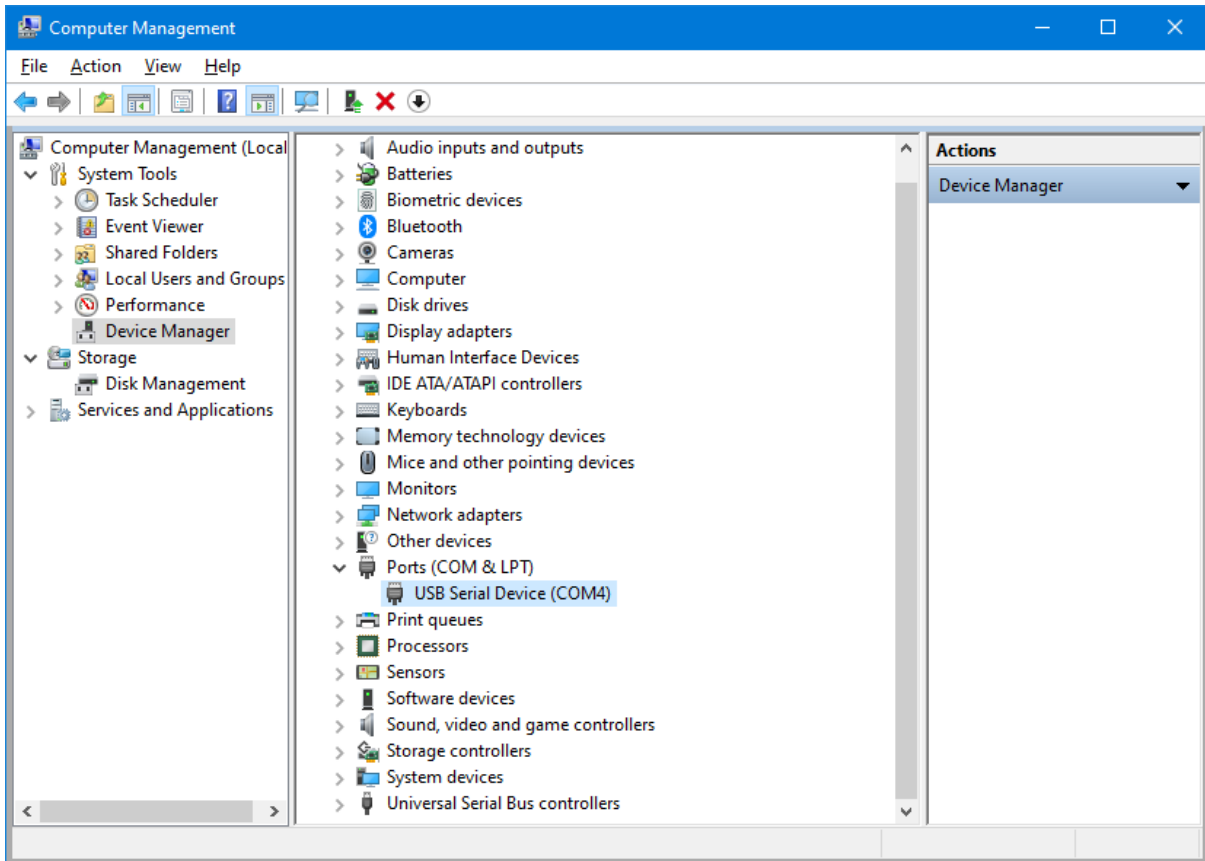

8.2. Serial tools

For serial tools, it is recommended to use Secure CRT or Putty, and other serial tools can also be used. The serial port baud rate of SV4401A is adaptive, usually we choose a baud rate of 115200, as shown in the figure below:

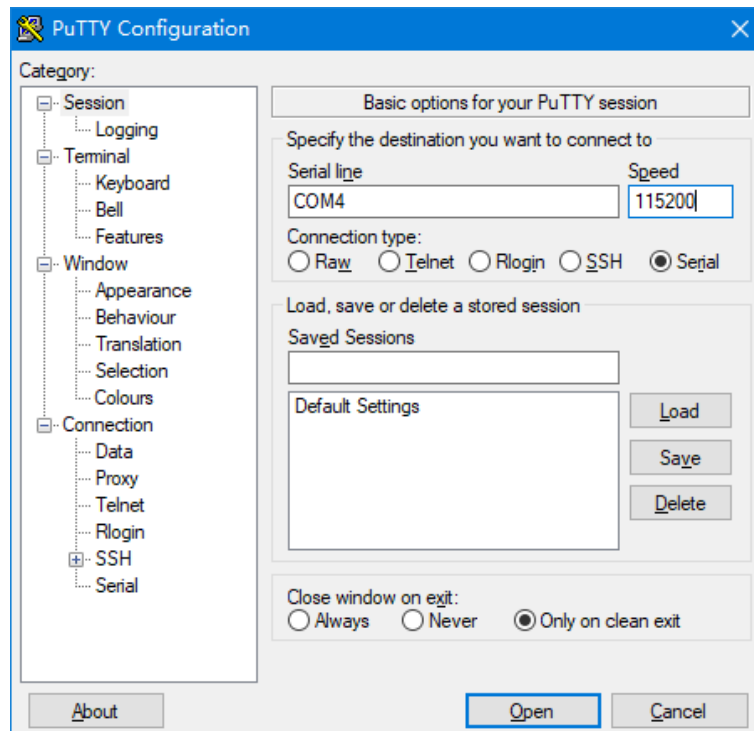

8.3. Command Syntax

A command line is a string of characters sent from PC to SV4401A. A command line has a command, a body, and a terminator. Each command line must begin with a command and must be terminated by a carriage return. The command line is a string of printable ASCII characters (032 - 126). Space characters (ASCII 032) and control characters other than CR (ASCII 013) and BS (ASCII 010) in the command string are ignored. The default terminator is the ASCII <CR> character. The command line interpretation begins upon receipt of the carriage return character. A typical command line is as follows:

Command {parameter 1} [parameter 2] [parameter 3] [parameter 4][parameter n]

Where { } represents the parameters must be passed in, [] stands for optional parameters.

8.4. Command Description

8.4.1 help

Use this command to list all the registered commands:

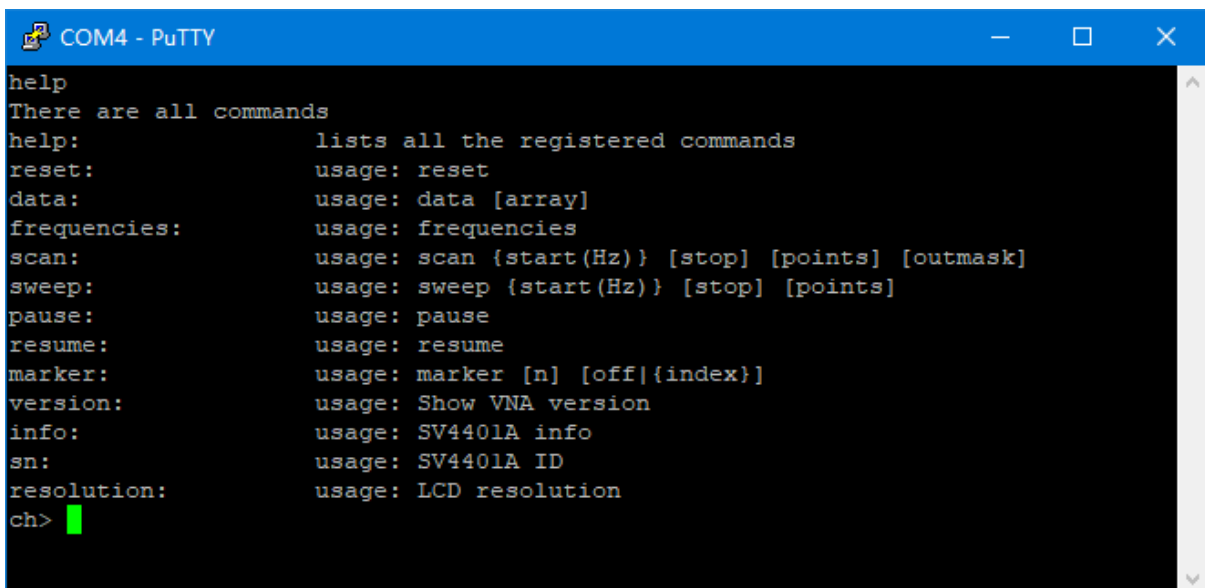

```
COM4 - PuTTY
help
There are all commands
help:          lists all the registered commands
reset:         usage: reset
data:          usage: data [array]
frequencies:   usage: frequencies
scan:          usage: scan {start(Hz)} [stop] [points] [outmask]
sweep:         usage: sweep {start(Hz)} [stop] [points]
pause:         usage: pause
resume:        usage: resume
marker:        usage: marker [n] [off|{index}]
version:       usage: Show VNA version
info:          usage: SV4401A info
sn:            usage: SV4401A ID
resolution:    usage: LCD resolution
ch>
```

8.4.2 reset

This command is used to reset the device. No parameters are required for this command. After using this command, the device will restart, and the USB will disconnect, so you need to restart the serial tool and reconnect.

8.4.3 data

This command is used to get the measurement data. The optional parameter [array] is used to specify the channel: 0 for s11, 1 for s21. When there is no parameter, executing this command will print s11 data by default.

data 0 : get S11 data, the first column of data printed is the real part of S11, and the second column of data printed is the imaginary part of S11.

data 1 : get S21 data, the first column of data printed is the real part of S21, and the second column of data printed is the imaginary part of S21.

8.4.4 frequencies

This command is used to get the frequency list of the sweep. No parameters are required for this command.

8.4.5 scan

This command is used to set start frequency, stop frequency, sweep points, and the printout format of the measurement results.

```
scan {start (Hz)} {stop (Hz)} [points] [outmask]
```

Parameter descriptions:

start	Start frequency in Hz.
stop	Stop frequency in Hz.
points	Sweep points, range from 101 to 1001
outmask	0: No printout; 1: Print the frequency value of each sweep point; 2: Print s11 data of each sweep point; 3: Print frequency value and s11 data of each sweep point; 4: Print s21 data of each sweep point; 5: Print frequency value and s21 data of each sweep point; 6: Print s11 data and s21 data of each sweep point; 7: Print frequency value, s11 data and s21 data of each sweep.

Example:

Set frequency range 200MHz - 500MHz:

```
scan 200000000 500000000
```

Set frequency range 200MHz - 500MHz, 301 points:

```
scan 200000000 500000000 301
```

Set frequency range 200MHz - 500MHz, 301 points, and print the frequency value of each point and the data for both channels.

```
scan 200000000 500000000 101 7
```

8.4.6 sweep

This command is used to set sweep mode, frequency, and sweep points. There are two ways to use **sweep** command.

Usage1:

```
sweep [start (Hz)] [stop (Hz)] [points]
```

If there is no parameter, executing this command will print the current sweep range and points; For the case of one integer parameter, the parameter is interpreted as start frequency; For the case of two integer parameters, parameters are interpreted as start and stop frequencies.

For the case of three integer parameters, the first two parameters are interpreted as start and stop frequencies, the third parameter is interpreted as sweep points.

Example: set start frequency to 200MHz, stop frequency to 500MHz, and sweep points to 156.

```
sweep 200000000 500000000 156
```

Usage2:

```
sweep [start | stop | span | center | cw | points] [value]
```

Parameter descriptions:

start	Set start frequency
stop	Set stop frequency
span	Set span frequency
center	Set center frequency
cw	Set CW frequency
points	Set sweep points, range from 101 to 1001
value	Frequency value in Hz or sweep points

Example: set start frequency to 500MHz.

```
sweep start 500000000
```

8.4.7 pause

Execute this command to pause sweep.

8.4.8 resume

Execute this command to resume sweep.

8.4.9 marker

This command is used to view or set the attributes of markers.

Usage:

```
marker [1|2|3|4] [on | off|{index}]
```

If there is no parameter, sending this command will get the attributes (index, frequency) of all the opened markers.

Example: get the attributes of all the opened markers:



```
COM4 - PuTTY
marker
1 30 264040000
2 40 352040000
3 450 3960000000
5 150 1320030000
ch>
```

For the case of one parameter, the parameter indicates to the marker number, sending this command will get the attributes (index, frequency) of the corresponding markers.

Example: get the attributes of marker 1:



```
COM4 - PuTTY
marker 1
1 30 264040000
ch>
```

For the case of two parameters, the first parameter indicates to the marker number, the second parameter can be 'on' , 'off' or index value, which is used to turn on/off or move the marker to the specified position.

Example: turn off marker 2:

```
marker 2 off
```

Example: move marker 1 to 56th sweep point:

```
marker 1 56
```

8.4.10 version

This command is used to check the firmware version. No parameters are required for this command.

8.4.11 info

This command is used to get the device information. No parameters are required for this

command.

8.4.12 sn

This command is used to get the unique 16-bit serial number of the device. No parameters are required for this command.

8.4.13 resolution

This command is used to get the LCD resolution. No parameters are required for this command.

9. Firmware upgrade

The firmware of SV4401A can be upgraded by virtual U-disk without a programmer (such as J-LINK). Upgrading can be done with a USB Type-C cable.

Connect SV4401A to Windows PC with the USB Type-C cable, press and hold the **Ctrl** button and power on SV4401A, and you will see the following screen:

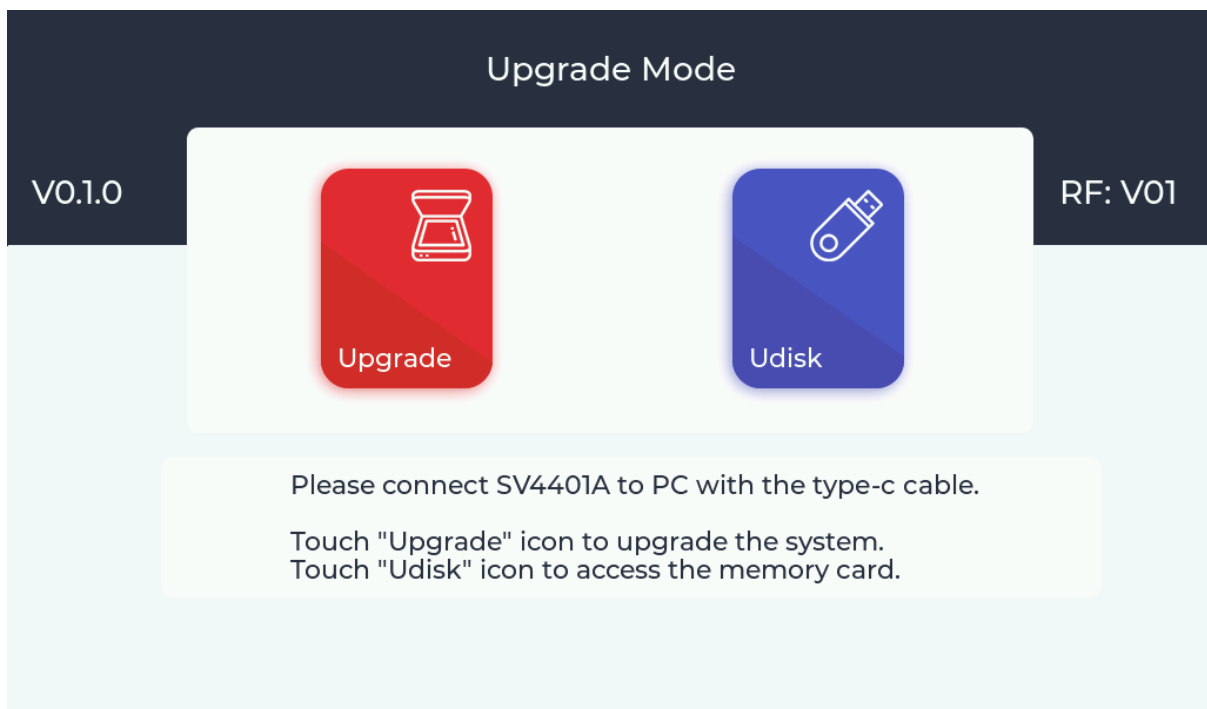

'V0.1.0' on the left represents the bootloader version, and 'RF: V01' on the right represents the hardware version.

Touch on **Udisk** icon and the device will be recognized as a U-disk drive on Windows PC, and the following screen will appear:



According to the prompt information, the file 'update.bin' is required, which can be downloaded from our official website: <https://www.sysjoint.com/en/content/?145.html>. Download the firmware file and unzip it to get 'update.bin'. Copy 'update.bin' into the U-disk.

Touch on **BACK** to return to the 'Upgrade Mode' page, then touch on **Upgrade** icon, and the following screen will appear:

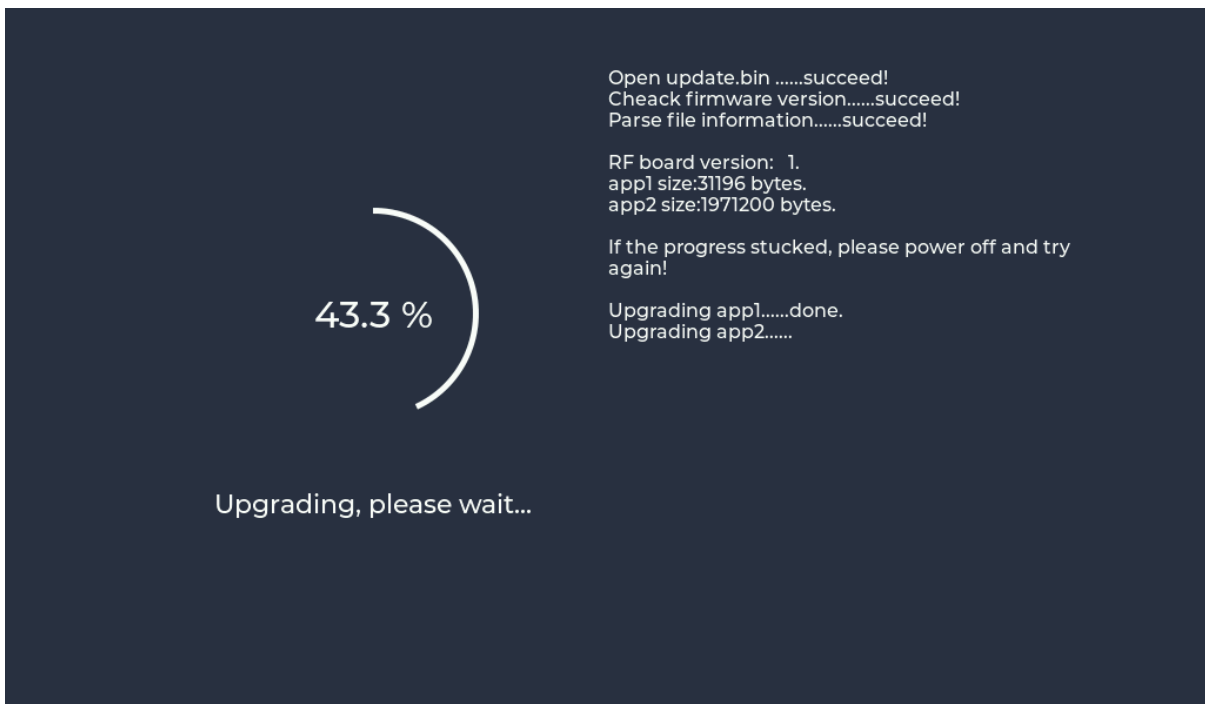

The following screen will appear when upgrading is finished. Please restart SV4401A and check

the firmware version from the startup screen.

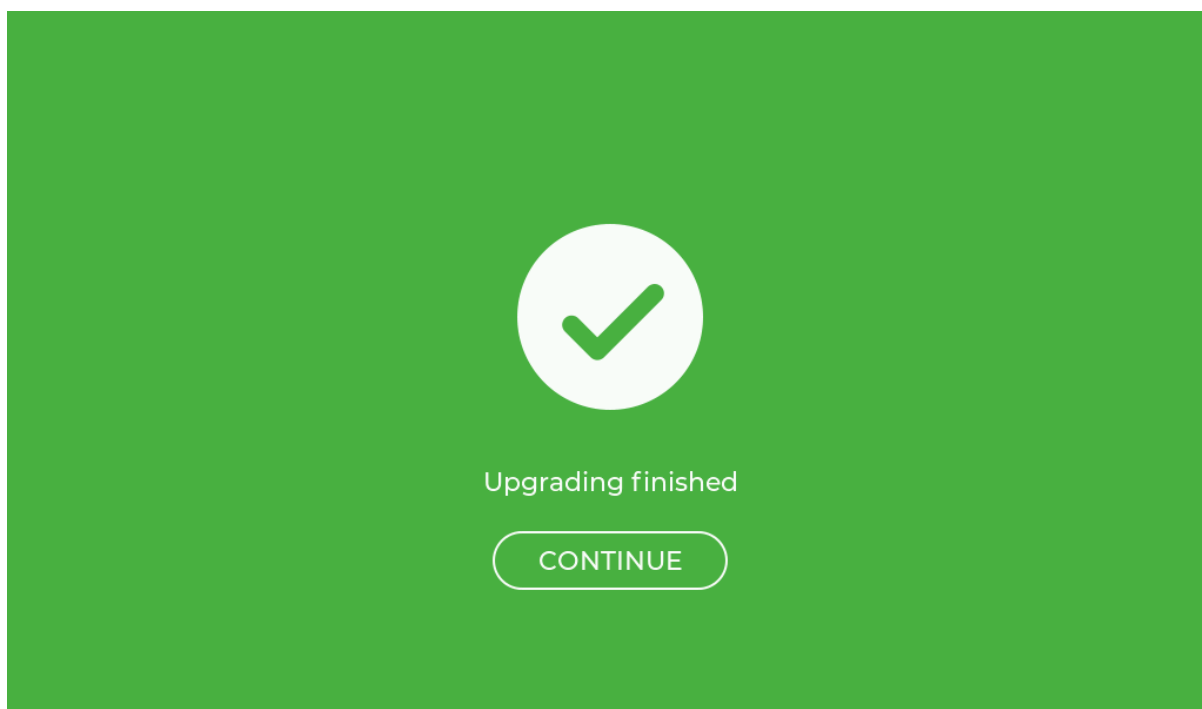

10. Hardware architecture

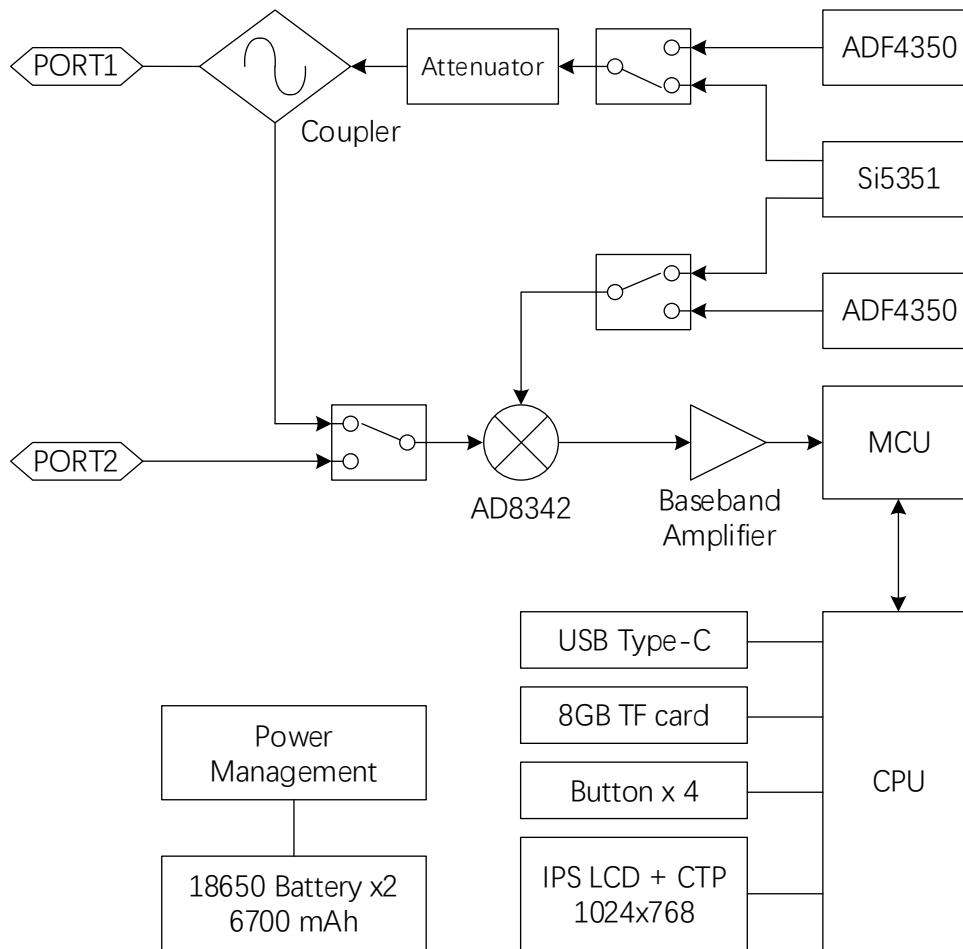

11. Shipping list

- SV4401A (with built-in 8GB memory card and 18650 battery x2) ×1
- SMA OPEN calibration piece ×1
- SMA SHORT calibration piece ×1
- SMA LOAD calibration piece ×1
- N to SMA adapter ×2
- SMA-KK adapter ×2
- SMA-JJ adapter ×1
- 50cm SMA-JJ RG316 coaxial cable ×2
- USB Type-C cable ×1
- Storage bag ×1