

PX-S1000

USER'S GUIDE

Initial Setup



Preparing a Power Supply



Turning Power On or Off



Using a Pedal



Using Headphones

Playing the Digital Piano



Selecting a Single Tone



Layering Two Tones

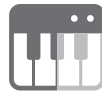

Splitting the Keyboard
Between Two Tones



Using the Metronome

Changing the Pitch

Adding Depth to Notes



Specifying the Tempo



Changing the Pitch in
Semitone Steps (Transpose)



Fine Tuning a Pitch (Tuning)



Using Chorus

Changing Sound Reverberation and Ambiance

Listening with Auto Playback

Recording Performances in Real-Time

Connecting with a Smart Device



Using the Sound Mode Effects
(Hall Simulator and Surround)



Listening to Songs
(Music Library)



Recording and Playing Back
Performances (MIDI Recorder)



Linking with a Smart Device
(APP Function)

• When the Digital Piano is being operated on battery power only, notes may sound distorted when performing or playing back a song at maximum volume. This is due to the difference between AC adaptor power and battery power, and does not indicate Digital Piano malfunction. If you notice distortion, switch to AC adaptor power or lower the volume level.

Included and Optional Accessories

Use only accessories that are specified for use with this Digital Piano.

Use of unauthorized accessories creates the risk of fire, electric shock, and personal injury.



- You can get information about accessories that are sold separately for this product from the CASIO catalog available from your retailer, and from the CASIO website at the URL or QR code below.

<https://support.casio.com/global/en/emi/manual/PX-S1000/>



About Music Score data

You can download music score data as a PDF file from the CASIO website, which you can access using the URL or QR code below. You will then be able to view music scores on your smart device. You can jump from the PDF file table of contents directly to the music score you want, and you can print out scores as needed.

<https://support.casio.com/global/en/emi/manual/PX-S1000/>



- Any reproduction of the contents of this manual, either in part or its entirety, is prohibited. Except for your own, personal use, any other use of the contents of this manual without the consent of CASIO is prohibited under copyright laws.
- IN NO EVENT SHALL CASIO BE LIABLE FOR ANY DAMAGES WHATSOEVER (INCLUDING, WITHOUT LIMITATION, DAMAGES FOR LOSS OF PROFITS, BUSINESS INTERRUPTION, LOSS OF INFORMATION) ARISING OUT OF THE USE OF OR INABILITY TO USE THIS MANUAL OR PRODUCT, EVEN IF CASIO HAS BEEN ADVISED OF THE POSSIBILITY OF SUCH DAMAGES.
- The contents of this manual are subject to change without notice.
- The actual appearance of the product may be different from that shown in the illustrations in this User's Guide.
- Company and product names used in this manual may be registered trademarks of others.

Contents

Overview and Setup **EN-3**

General Guide	EN-3
Preparing a Power Supply	EN-5
Turning Power On or Off	EN-6
Auto Power Off	EN-7
Using a Pedal	EN-7
Using Headphones	EN-8

Operations Common to All Modes **EN-8**

Touch Button Operations	EN-8
Notification Tones	EN-9

Digital Piano Operations **EN-10**

Listening to Demo Play	EN-10
Selecting a Tone	EN-10
Selecting a Single Tone	EN-10
Layering Two Tones	EN-11
Splitting the Keyboard Between Two Tones	EN-12
Changing Keyboard Response to Touch Pressure (Touch Response)	EN-12
Changing the Pitch in Semitone Steps (Transpose)	EN-13
Fine Tuning a Pitch (Tuning)	EN-14
Changing the Pitch in Octave Units (Octave Shift)	EN-14
Using the Sound Mode Effects (Hall Simulator and Surround)	EN-15
Using Chorus	EN-17
Using Brilliance	EN-17
Adjusting Acoustic Piano Sound Characteristics (Acoustic Simulator)	EN-18
Using the Metronome	EN-20
Specifying the Tempo	EN-21
Splitting the Keyboard for Duet Play	EN-22
Changing the Scale Tuning (Temperament) of the Keyboard	EN-23
Listening to Songs (Music Library)	EN-24
Recording and Playing Back Performances (MIDI Recorder)	EN-26
Creating a Recording	EN-27
Playing Back Recorded Content	EN-28

Configuring Settings **EN-29**

Adjusting the Upper1 Part Volume	EN-29
Configuring Upper2 Part and Lower Part Settings	EN-30
Adjusting the Volume Balance	EN-31
Audio-In Center Cancel	EN-31
Configuring MIDI Settings	EN-32
Changing Pedal Functions	EN-33
Other Settings	EN-34
Factory Reset (Initialization)	EN-36

Linking with a Smart Device (APP Function) **EN-37**

Troubleshooting **EN-38**

Reference **EN-40**

Product Specifications	EN-40
Tone List	EN-42
Music Library List	EN-43

MIDI Implementation Chart

Overview and Setup

General Guide

■ Front Panel

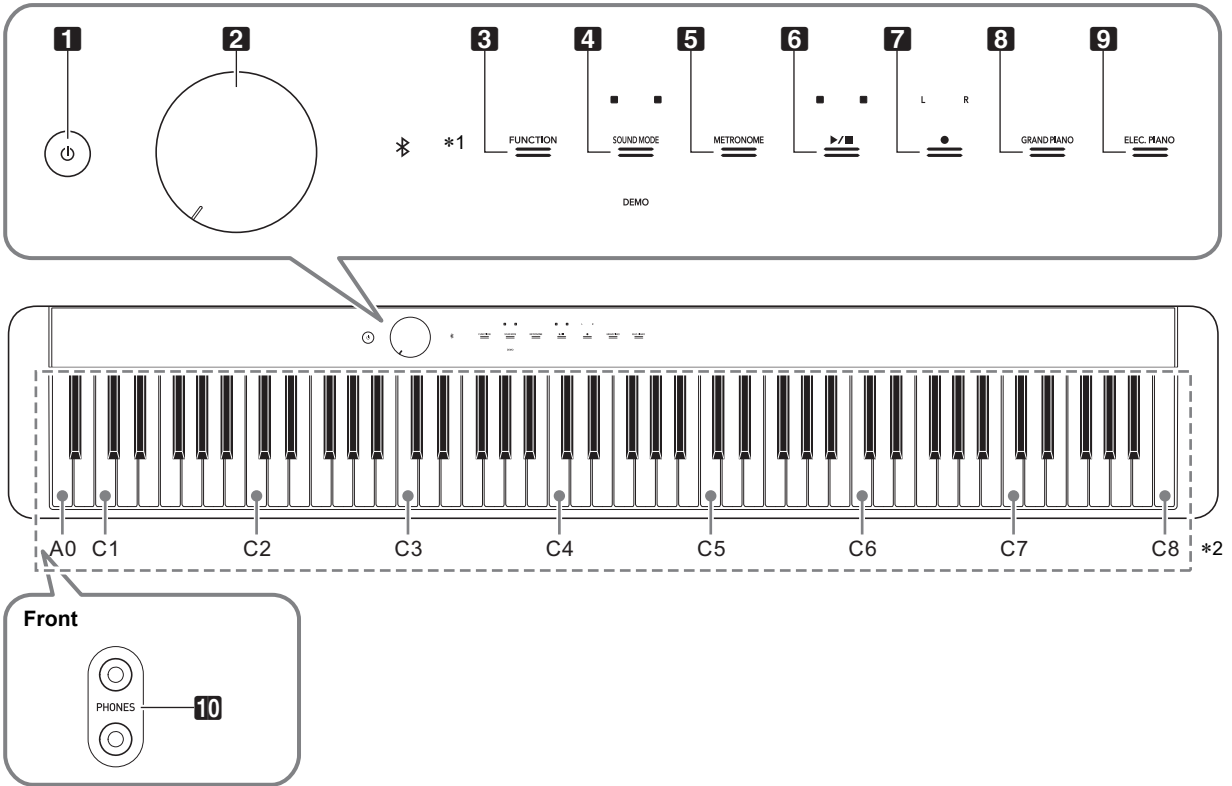

1 ⏻ (Power) button

2 Volume knob

3 **FUNCTION** button

4 **SOUND MODE** button

5 **METRONOME** button

6 ▶/■ button

7 ● (REC) button

8 **GRAND PIANO** button

9 **ELEC. PIANO** button

10 **PHONES** jacks

*1 Touch buttons

Buttons **3** through **9** are touch buttons whose lights light when power is turned on.

*2 Keyboard note names and pitches

The keyboard note names and pitches used in this manual follow the international standard. Middle C is C4, the lowest C is C1, and the highest C is C8. The illustration below shows keyboard key note names from C4 through C5.

C#4	E♭4	F#4	A♭4	B♭4		
C4	D4	E4	F4	G4	A4	
					B4	
						C5

■ Back

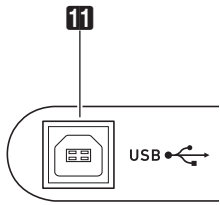

11 USB port

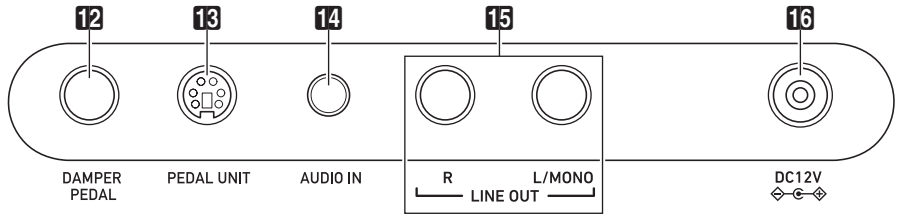

12 DAMPER PEDAL jack

13 PEDAL UNIT jack

14 AUDIO IN jack

15 LINE OUT R, L/MONO jacks

16 DC 12V terminal

■ Preparing the Music Stand

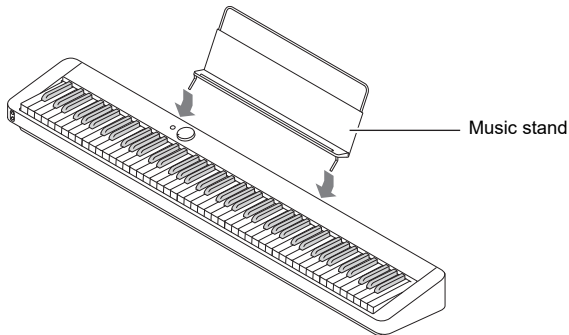

Preparing a Power Supply

Your Digital Piano uses an AC adaptor for power.

NOTE

- Though this Digital Piano supports battery operation, use of an AC adaptor is generally recommended.

■ Using the AC Adaptor

Make sure that you use only the AC adaptor specified for this Digital Piano. Use of a different type of AC adaptor can cause malfunction.

Specified AC Adaptor: AD-A12150LW
(JEITA Standard plug)

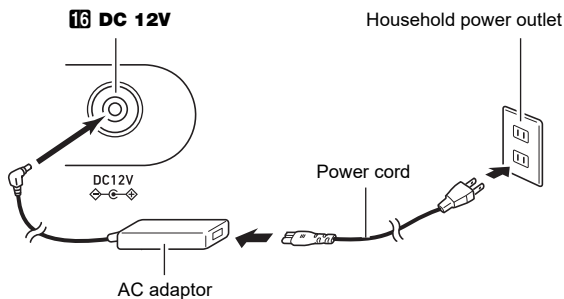

! IMPORTANT!

- **Never connect the AC adaptor (JEITA Standard, with unified polarity plug) that comes with this Digital Piano to any other device besides this Digital Piano. Doing so creates the risk of malfunction.**
 - **Be sure to turn off Digital Piano power before connecting or disconnecting the AC adaptor.**
 - **The AC adaptor will become warm to the touch after very long use. This is normal and does not indicate malfunction.**
- **Note the important precautions below to avoid damage to the power cord.**
 - **During Use**
 - Never pull on the cord with excessive force.
 - Never repeatedly pull on the cord.
 - Never twist the cord at the base of the plug or connector.
 - **During Movement**
 - Before moving the Digital Piano, be sure to unplug the AC adaptor from the power outlet.
 - **During Storage**
 - Loop and bundle the power cord, but never wind it around the AC adaptor.
 - **Never insert metal, pencils, or any other objects into the product's DC12V terminal. Doing so creates the risk of accident.**
 - **Do not try to use the power cord that comes with the product with another device.**
 - **Plug the AC adaptor into a power outlet that is close to the Digital Piano. This lets you immediately unplug from the power outlet should any problem occur.**
 - **The AC adaptor is intended for indoor use only. Do not leave it in a location where it can become wet. Also, do not place a vase or any other container of liquid on the AC adaptor.**
 - **Make sure that the AC adaptor does not become covered with a newspaper, table cloth, curtain, or any other type of fabric.**
 - **If you do not plan to use the Digital Piano for a long time, unplug the AC adaptor from the power outlet.**
 - **The AC adaptor cannot be repaired. If your AC adaptor malfunctions or becomes damaged, you need to purchase a new one.**
 - **AC Adaptor Usage Environment**
 - Temperature: 0 to 40°C
 - Humidity: 10% to 90%RH
 - **Output Polarity:** ◊—⊖—◊

■ Using Batteries

! IMPORTANT!

- Be sure to turn off power before loading batteries.
- It is up to you to prepare six commercially available alkaline batteries.
- Note the precautions below while the Digital Piano is turned upside down to load batteries.
 - Take care to avoid injury due to pinching your fingers under the Digital Piano.
 - Do not allow the Digital Piano to tip over or otherwise be subjected to strong impact. Impact can damage the volume knob and keyboard keys.

1. Open the battery cover on the bottom of the Digital Piano.

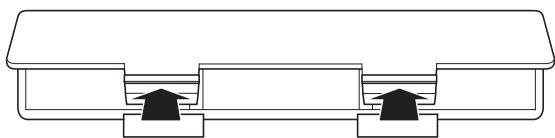

2. Load six AA-size batteries into the battery compartment.

Make sure the positive ⊕ and negative ⊖ ends of the batteries are facing as marked on the Digital Piano.

3. Insert the tabs of the battery cover into the holes along the side of the battery compartment, and close the cover.

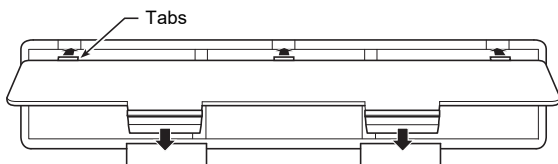

■ Low Battery Indicator

Low power is indicated when the lights of all the touch buttons, except for the **3 FUNCTION**, start to flash. When this happens, try lowering the volume level. If this does not stop the flashing, replace the batteries with new ones.

! IMPORTANT!

- Using the Digital Piano while batteries are very low can cause it to turn off suddenly. This can cause data stored in Digital Piano memory to be corrupted or lost.
- Low battery power can cause abnormal operation. If this happens, replace batteries with new ones.

Turning Power On or Off

1. Before turning on power, rotate the **2** volume knob as far as it will go in the direction shown in the illustration below.

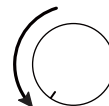

2. Press the **1** ⏻ (Power) button to turn on power.



Turning on power will cause the lights of the front panel touch button to light in sequence from left to right (**3 FUNCTION** to **9 ELEC. PIANO**). The Digital Piano is ready to play when all touch button lights are lit.

- After pressing **1** ⏻ (Power) to turn on power, do not press any pedal until the Digital Piano is ready to play (all touch buttons lit).
- Power may not turn on if you press the **1** ⏻ (Power) button too lightly. This does not indicate malfunction. If this happens, apply more pressure when you press the **1** ⏻ (Power) button.

3. Use the **2** volume knob to adjust volume.
4. To turn off power, hold down the **1** ⏻ (Power) button until all lit touch button lights turn off.

NOTE

- Pressing the **1** ⏻ (Power) button to turn off power actually puts the Digital Piano into a standby state. Minute amounts of current continue to flow within the Digital Piano in the standby state. If you do not plan to use the Digital Piano for a long time or if there is a lightning storm in your area, be sure to unplug the AC adaptor from the power outlet.
- Turning off power normally causes the tone number and other settings to return to their initial defaults. You can enable Auto Resume (page EN-34), which will save most settings when power is turned off.
- If Auto Resume is disabled, turning off power will initialize settings, except for tuning (page EN-14) and touch button luminosity (page EN-34).

■ Power On Alert

After about six minutes of non-operation while the Digital Piano is being powered by its AC adaptor, the Power On Alert function will cause touch button lights to turn on and off sequentially to remind you that power is on. Button lights will return to normal (all button lights lit) if you touch a button, play something on the keyboard, or perform some other operation. To turn off power, hold down the **1** **⏻** (Power) button until all lit touch button lights turn off.

NOTE

- You can enable or disable the power on reminder as required. See “Other Settings” (page EN-34).
- If you are using batteries to power the Digital Piano, power will turn off automatically after about six minutes of non-use. See “Auto Power Off” (page EN-7).

■ Returning to Initial Factory Defaults

You can use Factory Reset (Initialization) to return the Digital Piano’s stored data and settings to their initial factory defaults any time you want. For more information, see “Factory Reset (Initialization)” (page EN-36).

Auto Power Off

This Digital Piano is designed to turn off automatically to avoid wasting power after no operation is performed for a preset amount of time. The Auto Power Off trigger time is about four hours when power is being supplied by the AC adaptor, or six minutes under battery power.

- You can disable Auto Power Off to ensure that power does not turn off automatically during a concert, etc. To disable Auto Power Off, perform the procedure below.

■ To enable or disable Auto Power Off

1. While holding down **3** **FUNCTION**, press the **B \flat 0** keyboard key.



B \flat 0

- Each press of the B \flat 0 keyboard key sounds a notification tone and toggles Auto Power off between enabled and disabled. For more information, see “Notification Tones” (page EN-9).

2. After the setting is the way you want, release **3** **FUNCTION**.

Using a Pedal

Connect the supplied pedal (SP-3) to the **12** **DAMPER PEDAL** jack.

Back

12 **DAMPER PEDAL** jack (Standard jack (6.3mm))

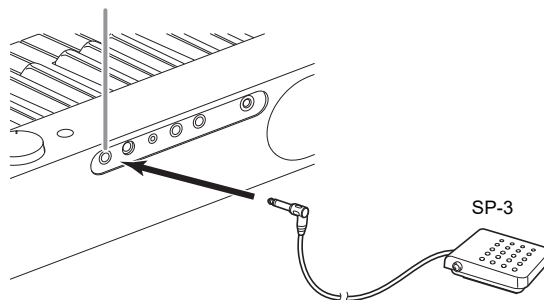

This pedal functions as a damper pedal under initial Digital Piano default settings. To change it to a different function (soft, sostenuto, etc.), see “Changing Pedal Functions” (page EN-33).

■ PEDAL UNIT Jack

You can connect the optionally available 3-Pedal Unit (SP-34) to the **13** **PEDAL UNIT** jack on the back of the Digital Piano. You can then use the pedals for expression that is similar to that available on an acoustic piano.

SP-34 Pedal Functions

● Damper Pedal

Pressing the damper pedal while playing will cause the notes you play to reverberate. The SP-34 pedal also supports half-pedal operation, so pressing the pedal part way applies only a partial damper effect.

● Soft Pedal

Pressing this pedal suppresses notes played on the keyboard after the pedal was pressed, and makes them sound softer.

● Sostenuto Pedal

Only the notes of the keys that are depressed when this pedal is pressed are sustained, even if the keyboard keys are released, until the pedal is released.

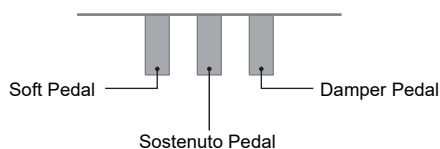

NOTE

- A separately available pedal unit can be used at the same time as the supplied pedal.

Using Headphones

Using headphones cuts off output from the built-in speakers, which means you can practice playing even late at night without disturbing others.

- Be sure to turn down the volume before connecting headphones.

10 PHONES jacks (Stereo mini jack (3.5mm))

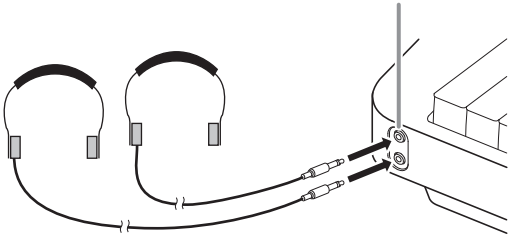

NOTE

- Headphones do not come with the Digital Piano.
- Use commercially available headphones. See page EN-1 for information about options.

IMPORTANT!

- Do not listen to very high volume output over headphones for long period. Doing so creates the risk of hearing damage.
- If you are using headphones that require an adaptor plug, make sure you do not leave the adaptor plugged in when you unplug the headphones. If you do, nothing will sound from the speakers when you play.

■ To output from the speakers while headphones are connected

Enable the “Speaker Out” setting under “Other Settings” (page EN-34) to output sound from the speakers, even if a plug is plugged into either of the PHONES jacks.

Operations Common to All Modes

IMPORTANT!

- Unless otherwise specifically noted, all of the procedures in this manual assume that the Digital Piano is in its initial power on state (immediately after you turn on power). If you run into problems with a procedure, turn Digital Piano power off and back on, and then try performing the procedure again.
- Note that turning off Digital Piano power during a procedure causes any pending unsaved data to be deleted.

Touch Button Operations

Turning on Digital Piano power causes the lights of all of the front panel touch buttons to light.



IMPORTANT!

- When operating a touch button, touch it firmly with a bare finger. Touch buttons will not respond if you touch them while wearing gloves.
- If a touch button does not respond, perform the steps below to increase touch button sensitivity.
 - (1) Turn off the Digital Piano.
 - (2) While holding down the C8 keyboard key (the one on the far right), press the **1** (Power) button.
 - Keep the C8 keyboard depressed until the touch buttons start to light in sequence from left to right (from **3** FUNCTION to **9** ELEC. PIANO). You do not need to keep the **1** (Power) button depressed.

■ Touch Button Light Auto Off (Panel Light Setting)

To save power, you can configure a setting that will turn off all button lights, except for **3** FUNCTION, after a certain period of non-operation. You can specify the amount of non-operation time until lights turn off, or you can specify that lights should remain lit (initial default setting while the AC adaptor is connected). For information about how to configure these settings, see “To change the panel light setting” (page EN-35).

NOTE

- To turn the touch button lights back on, touch the **3** FUNCTION.
- Turning on the Digital Piano under battery power only (without AC adaptor power) will cause the Panel Light Setting to change automatically to 60 seconds to conserve power. You can change the Panel Light Setting if you want.
- Turning off the Digital Piano, connecting the AC adaptor, and turning power back on will automatically cause “Off” to be selected for the Panel Light Setting (if Auto Resume is disabled).

■ Touch Button Only Operations

Touching a button firmly and immediately releasing it will perform the operation assigned to the touch button. For example, touching **9** ELEC. PIANO selects the ELEC.PIANO tone, while touching **5** METRONOME starts (or stops) the metronome.

■ Touch Button + Keyboard Key Combinations

A number of different Digital Piano settings can be configured by using a touch button (except for the **7** ● (REC) button) in combination with a keyboard key. As an example, the procedure shows how to select the JAZZ ORGAN tone.



1. Hold down **8** GRAND PIANO.

- Until you release **8** GRAND PIANO in step 3 below, you can use keyboard keys to select tones and to configure other settings. For information about what operations you can perform while **8** GRAND PIANO is depressed, see the separate “Keyboard Function List”.

2. Press the B1 keyboard key.

This selects the JAZZ ORGAN tone and causes the confirmation tone to sound using the JAZZ ORGAN tone.

3. Release **8** GRAND PIANO.

- Now you can play on the keyboard with the JAZZ ORGAN tone.

Notification Tones

When you perform a touch button and keyboard key combination operation (page EN-9), a notification tone will sound when you press the keyboard key to let you know the result of the operation. Notification tone types are described below.

■ Notification Tone Types

This type of tone sounds:	When this happens:
Received tone	A keyboard key operation is received and applied. This tone sounds if a setting is enabled (turned on) when you press a keyboard key that toggles the setting between enabled and disabled.
Invalid tone	You press the wrong keyboard key. This tone lets you know the operation is invalid.
Upper limit, lower limit tone	You press a keyboard key that would cause the setting to become greater than the upper limit or less than the lower limit.
Initialization tone	Settings were returned to the initial defaults. This tone sounds when you press the plus (+) and minus (-) keyboard keys at the same time, etc.
Option tone	A setting option is changed by pressing a keyboard key that cycles through options. The number of times the tone sounds depends on the option that is selected.
Off tone	A setting is disabled (turned off).
Reference tone	As you use the plus (+) and minus (-) keyboard keys to change a setting value, a reference tone will sound to signal when the keyboard key operation result in certain types of values to be set. In the case of whole number (non-fraction) values, the reference tone will sound whenever the setting becomes one that is multiple of 10 (10, 20, etc.) In the case of fraction values (like 440.2), the reference tone will sound whenever the setting becomes a value that is a whole number (440, 441, etc.)
End tone	The final keyboard key was pressed for a setting operation that requires multiple keyboard key operations. For example, when you input a three-digit tempo setting, this tone will sound when you press the keyboard key for the third digit.

■ Notification Tone Sets

Your Digital Piano comes with three different notification tone sets from which you can choose. You can also disable notification tones, if you want. For information about how to change the notification tone set, see “Other Settings” (page EN-34).

Digital Piano Operations

Listening to Demo Play

1. Hold down **3** FUNCTION.

This causes the DEMO light to flash, and the **4** SOUND MODE light to turn light (and the lights of other buttons to turn off).

2. Touch **4** SOUND MODE.

This will cause the **6** ▶/■ and DEMO lights to light, and starts playback of the one demo song (and the lights of buttons except for **6** ▶/■ to turn off). After demo song playback is complete, it will continue with playback of Music Library (page EN-24) songs.

- The operations below are supported during demo play.

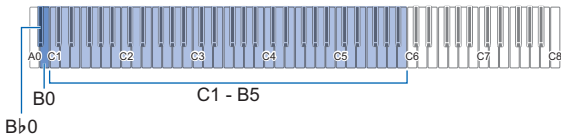

To do this:	Perform this operation:
Skip forward to the next song	While holding down 6 ▶/■, press the B0 keyboard key.
Skip back to the previous song	While holding down 6 ▶/■, press the B♭0 keyboard key.
Jump to a specific song	While holding down 6 ▶/■, press a keyboard key from C1 through B5.*
Return to the first song (demo song)	While holding down 6 ▶/■, press the B♭0 and B0 keyboard keys at the same time.

* For information about the song number assigned to each keyboard key, see the "Music Library List" (page EN-43).

3. To stop demo song playback, touch **6** ▶/■.

This causes the button lights that turned off in the above procedure to light again.

NOTE

- If Auto Power Off is enabled, power will turn off automatically after the prescribed time even during demo song play. To avoid this, you can use the procedure under "To enable or disable Auto Power Off" (page EN-7) to disable Auto Power Off.

Selecting a Tone

Your Digital Piano comes with 17 tones, including three grand piano tones that are assigned to the entire keyboard range, plus one bass tone that can be assigned to lower range only. In addition to assigning a single tone to the keyboard, you can also layer two different tones and you can split the left side and right side of the keyboard between tones.

Selecting a Single Tone

To select a tone using keyboard keys

1. While holding down **3** GRAND PIANO, press a keyboard key from A0 through C#2.

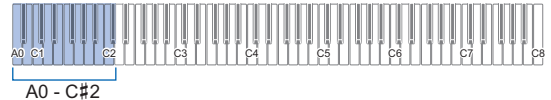

- For example, pressing the F#1 keyboard key will select the HARPSICHORD tone and will sound the confirmation tone using the HARPSICHORD tone.
- For information about the tone assigned to each keyboard key, see "Tone List" (page EN-42).

2. Release **3** GRAND PIANO.

To select a tone with the touch buttons

1. Touch a button as explained below to select the tone you want.

To select this tone:	Touch:
GRAND PIANO CONCERT	8 GRAND PIANO
ELEC.PIANO	9 ELEC. PIANO

- If tones are currently layered (page EN-11) or if the keyboard is split between two tones (page EN-12), performing the above procedure to select a tones will cancel the layer and split settings.

Grand Piano Tones

The characteristics of each of the three grand piano tones are described in the table below.

Tone name	Description
CONCERT	A full concert grand piano tone for dynamic and natural tone changes.
BRIGHT	A bright and clear piano sound.
MELLOW	A warm, subdued piano tone.

Layering Two Tones

Layering makes it possible to sound with two different tones at the same time. The tone that is layered onto another tone is the “Upper2 part tone”, which in this manual is referred to as the “Upper2 tone”. The tone upon which the Upper2 tone is layered is the “Upper1 part tone”, which is referred to as the “Upper1 tone”.

■ To layer two tones

1. Use the procedure under “Selecting a Single Tone” (page EN-10) to select the Upper1 tone.

2. Select the Upper2 tone.

- (1) While holding down **[9] ELEC. PIANO**, press a keyboard key from A0 through C#2.

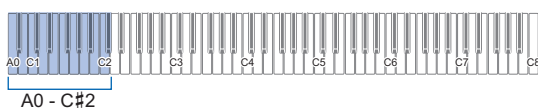

- For example, pressing the A♭1 keyboard key will select STRINGS 1 as the Upper2 tone and will sound the confirmation tone using the STRINGS 1 tone.
- For information about the tone assigned to each keyboard key, see “ELEC.PIANO Button + Keyboard Key” in the separate “Keyboard Function List”.

- (2) Release **[9] ELEC. PIANO**.

3. Enable layering.

- (1) While holding down **[9] ELEC. PIANO**, press the C7 keyboard key.

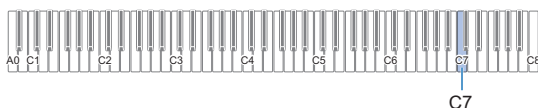

- Each press of C7 toggles layering between enabled and disabled. A notification tone (page EN-9) will sound to let you know whether layering is enabled or disabled.

- (2) Release **[9] ELEC. PIANO**.

- Now when you press a keyboard key to play, the two tones (Upper1 and Upper2) you selected will sound at the same time.
- To go back to playing with the Upper1 tone only, disable the layer function.

■ To unlayer the keyboard

You can perform either of the operations below to unlayer the keyboard.

- While holding down **[9] ELEC. PIANO**, press the C7 keyboard key. Each press of C7 toggles layering between enabled and disabled. After the notification tone sounds (page EN-9) to confirm that layering is disabled, release **[9] ELEC. PIANO**.
- Touch **[8] GRAND PIANO** or **[9] ELEC. PIANO**. This unlayers the keyboard and selects the tone that corresponds to the button you touched.

NOTE

- You can adjust the volume of the Upper2 part and configure other Upper2 part settings. For more information, see “Configuring Upper2 Part and Lower Part Settings” (page EN-30).
- For information about adjusting the Upper1 part volume, see “Adjusting the Upper1 Part Volume” (page EN-29).

Splitting the Keyboard Between Two Tones

You can use the lower range of the keyboard to sound a bass tone. When the keyboard is split between a left side and a right side range, the tone assigned to the lower (left side) range is the “Lower part tone”, which is referred to as the “Lower tone” in this manual. The tone assigned to the upper (right side) range is the “Upper1 part tone”, which is referred to as the “Upper1 tone”.

Any one of the 17 non-bass tones can be assigned to the upper range.

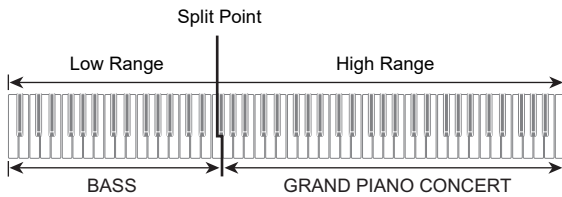

■ To use split to play bass notes in the lower range

1. Use the procedure under “[Selecting a Single Tone](#)” (page [EN-10](#)) to select the upper range (Upper1) tone.
2. While holding down **[9] ELEC. PIANO**, press the **D2** keyboard key.
This assigns the bass tone to the lower range.



3. Release **[9] ELEC. PIANO**.

NOTE

- You can adjust the volume of the Lower part and configure other Lower part settings. For more information, see “[Configuring Upper2 Part and Lower Part Settings](#)” (page [EN-30](#)).

■ To unsplit the keyboard

You can perform either of the operations below to unsplit the keyboard.

- While holding down **[9] ELEC. PIANO**, press a keyboard key from A0 through C#2. This unsplit the keyboard and makes the tone assigned to the keyboard key you press become the Upper2 tone (page [EN-11](#)).
- Touch **[3] GRAND PIANO** or **[9] ELEC. PIANO**. This unsplit the keyboard and selects the tone that corresponds to the button you touched.

Changing Keyboard Response to Touch Pressure (Touch Response)

Touch Response alters tone volume in accordance with keyboard pressure (speed). This provides you some of the same expressivity you get on an acoustic piano.

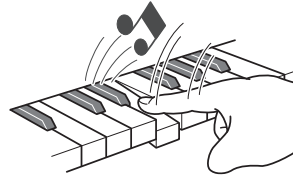

Pressing fast produces louder notes.

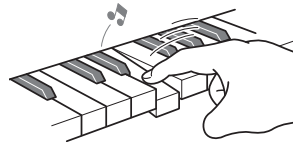

Pressing slowly produces softer notes.

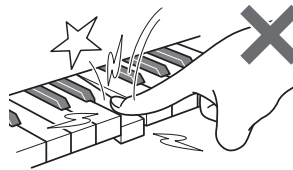

Do not try to use too much pressure.

■ To change touch response sensitivity

1. While holding down **8 GRAND PIANO**, press a keyboard key from F#7 through B7.

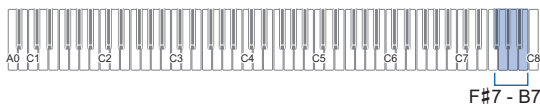

- The table below shows the Touch Response sensitivity settings assigned to each keyboard key.

Pressing this key:	Selects this setting:	Which does this:
F#7	Off	Disables Touch Response. Sound volume is fixed, regardless of key press speed.
G7	1: Light	Makes production of a louder sound easier, so touch feels lighter than "Normal".
A♭7	2: Medium light	
A7	3: Normal	Specifies normal sensitivity.
B♭7	4: Medium heavy	Makes production of a louder sound more difficult, so touch feels heavier than "Normal".
B7	5: Heavy	

2. Release **8 GRAND PIANO**.

Changing the Pitch in Semitone Steps (Transpose)

Transpose lets you raise or lower the overall pitch of the Digital Piano in semitone steps.

You can use this feature to raise or lower the keyboard key and to play a piece in a key that is more comfortable for you, or to adjust to a key that better matches a vocalist, etc.

■ To change the transpose setting

1. While holding down **8 GRAND PIANO**, press the E7 or F7 keyboard key.

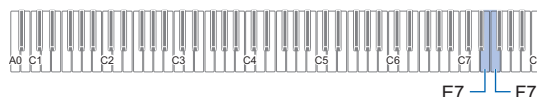

Pressing this key:	Does this:
E7	Lowers the pitch one semitone.
F7	Raises the pitch one semitone.
E7 + F7	Returns pitch to the initial default setting.

- You can change the pitch of the keyboard within the range of -12 to +12 semitones.

2. After the setting is the way you want, release **8 GRAND PIANO**.

Fine Tuning a Pitch (Tuning)

Use the tuning feature when you need to adjust the pitch slightly to play along with another musical instrument.

- The tuning feature specifies the frequency of the A4 note. You can set a frequency within the range of 415.5 to 465.9 Hz. The initial default setting is 440.0 Hz.
- You can change the frequency in 0.1 Hz steps.

■ To change the tuning setting

1. Hold down **3** FUNCTION.
 - Do not release **3** FUNCTION until step 3, below.
2. Use the keyboards keys below to adjust tuning.

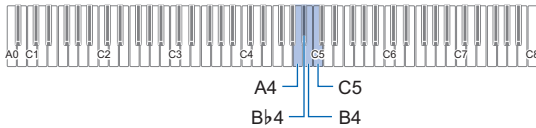

Pressing this key:	Does this:
A4	Sets the A4 frequency to 440.0 Hz.
Bb4	Sets the A4 frequency to 442.0 Hz.
B4	Lowers the A4 frequency 0.1 Hz.*
C5	Raises the A4 frequency 0.1 Hz.*

* A reference tone (page EN-9) sounds whenever the setting values becomes an integer (whole number), such as 440, 441, etc.

3. After selecting the tuning you want, release **3** FUNCTION.
 - The adjusted tuning setting is retained even if you turn off power.

Changing the Pitch in Octave Units (Octave Shift)

Octave shift lets you individually raise or lower the pitches of the Upper1 part and Upper2 part in octave units.

■ To change the Upper1 part pitch in octave units

1. While holding down **8** GRAND PIANO, press the D7 or Eb7 keyboard key.

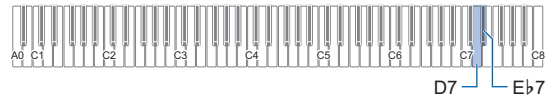

Pressing this key:	Does this:
D7	Lowers the pitch of the Upper1 part one octave.
Eb7	Raises the pitch of the Upper1 part one octave.
D7+ Eb7	Returns the pitch of the Upper1 part to the initial default setting.

- You can shift the octave within the range of -2 to +2.

2. After the setting is the way you want, release **8** GRAND PIANO.

■ To change the Upper2 part pitch in octave units

1. While holding down **9** ELEC. PIANO, press the Eb7 or E7 keyboard key.



Pressing this key:	Does this:
Eb7	Lowers the pitch of the Upper2 part one octave.
E7	Raises the pitch of the Upper2 part one octave.
Eb7 + E7	Returns the pitch of the Upper2 part to the initial default setting.

- You can shift the octave within the range of -2 to +2.

2. After the setting is the way you want, release **9** ELEC. PIANO.

Using the Sound Mode Effects (Hall Simulator and Surround)

You can use **[4] SOUND MODE** to enable and disable the effects described below.

● Hall Simulator

The hall simulator effect simulates the rich clarity, unconstrained brilliance, and other distinctive acoustic characteristics of world-famous concert halls and structures. The depth of the hall simulator effect applied to the Digital Piano's sound source and the depth applied to externally input audio* can be adjusted separately.

* Audio input from a Bluetooth connected smart device or an audio device connected to the Digital Piano's **[14] AUDIO IN** jack.

● Surround

The Surround effect creates acoustics that make the sound from the speakers seem like it is coming from multiple directions (virtual surround).

NOTE

- The initial power on default setting is Hall Simulator enabled and Surround disabled.
- The Surround effect is not applied to the output from the Digital Piano's **[10] PHONES** jacks or **[15] LINE OUT R, L/ MONO** jacks.

■ To enable or disable the Hall Simulator and Surround effects

1. Touch **[4] SOUND MODE**.

- Each touch will cycle between the settings, and the current setting is indicated by the LED lights as shown below.

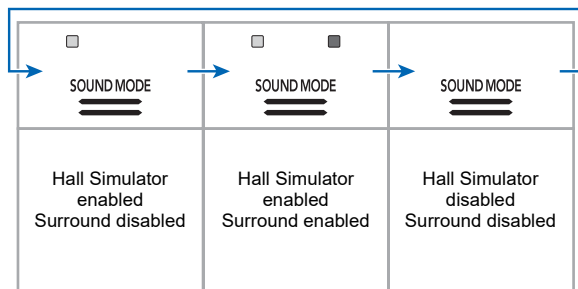

■ To specify the Hall Simulator type

1. While holding down **[4] SOUND MODE**, press a keyboard key from **A0** through **C1**.

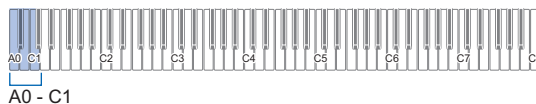

Pressing this key:	Selects this setting:	Description
A0	1: STANDARD HALL	Standard concert hall
Bb0	2: OPERA HALL	Uniquely shaped Sydney Concert Hall
B0	3: BERLIN HALL	Berlin arena type classic concert hall
C1	4: BRITISH STADIUM	Large outdoor stadium in the London suburbs

2. Release **[4] SOUND MODE**.

■ To adjust the depth of the hall simulator effect

1. Perform step 1 under “[To specify the Hall Simulator type](#)” to select a hall simulator effect.
2. While holding down **[4] SOUND MODE**, use the keyboard keys below to adjust hall simulator depth.

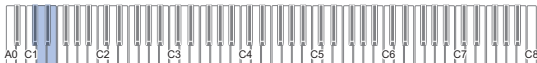

C#1 - E1

Pressing this key:	Does this:
C#1	Lowers the effect depth applied to the Digital Piano sound source one level.
D1	Raises the effect depth applied to the Digital Piano sound source one level.
C#1 + D1	Returns the effect depth applied to the Digital Piano sound source to the initial default setting.
E♭1	Lowers the effect depth applied to externally input audio* one level.
E1	Raises the effect depth applied to externally input audio* one level.
E♭1 + E1	Returns the effect depth applied to externally input audio* to the initial default setting.

* Audio input from a Bluetooth connected smart device or an audio device connected to the Digital Piano's **[14] AUDIO IN** jack.

- Effect depth can be set to a value in the range of 0 (no effect) to 42 (maximum depth). As you use the keyboard keys to change the setting, the reference tone (page [EN-9](#)) will sound any time the value becomes a multiple of 10 (10, 20, etc.)

3. After the setting is the way you want, release **[4] SOUND MODE**.

■ To specify the Surround type

1. While holding down **[4] SOUND MODE**, press the F1 (Surround Type 1) or F#1 (Surround Type 2) keyboard key.

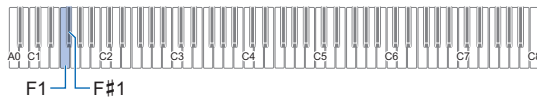

2. Release **[4] SOUND MODE**.

Using Chorus

Chorus is a function that adds depth and breadth to notes.

■ To apply a chorus effect to a tone

1. While holding down **4** **SOUND MODE**, press a keyboard key from G1 through B1.

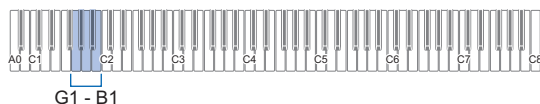

Pressing this key:	Selects this setting:	Which does this:
G1	Tone	Specifies the initial setting of each tone.
A \flat 1	1	Applies light chorus.
A1	2	Applies medium chorus.
B \flat 1	3	Applies deep chorus.
B1	4	Applies a sweeping flanger effect.

2. Release **4** **SOUND MODE**.

Using Brilliance

Brilliance can be used to make a sound brighter or mellow.

■ To adjust brilliance

1. While holding down **4** **SOUND MODE**, press the C2 or C#2 keyboard key.

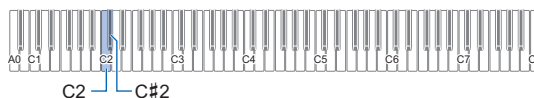

Pressing this key:	Does this:
C2	Lowers the brilliance setting by 1.
C#2	Raises the brilliance setting by 1.
C2 + C#2	Returns brilliance to the initial default setting.

- You can specify a setting value in the range of -3 to $+3$. A setting of $+1$ or greater gives notes a brighter feel, while -1 or less makes notes sound more mellow.

2. After the setting is the way you want, release **4** **SOUND MODE**.

Adjusting Acoustic Piano Sound Characteristics (Acoustic Simulator)

The tones of your Digital Piano have built-in elements that give them the reverberation characteristics of an acoustic piano. You can use the procedure below to adjust the characteristics of notes.

■ To adjust acoustic piano sound characteristics

1. Hold down **4** SOUND MODE.

- Do not release **4** SOUND MODE until step 3, below.

2. Use the keyboard keys shown in the table below to configure the setting item you want.

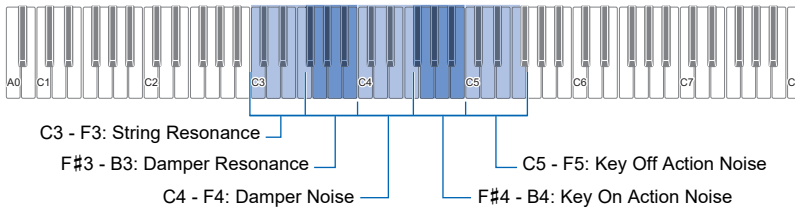

Setting Item	Setting					
	Tone	Off	1	2	3	4
String Resonance	C3	C#3	D3	E♭3	E3	F3
Damper Resonance	F#3	G3	A♭3	A3	B♭3	B3
Damper Noise	C4	C#4	D4	E♭4	E4	F4
Key On Action Noise	F#4	G4	A♭4	A4	B♭4	B4
Key Off Action Noise	C5	C#5	D5	E♭5	E5	F5

- For each setting item, press the keyboard key that corresponds to the setting you want. For example, to select the 4 setting for String Resonance, press the F3 keyboard key.
- For more information about setting items and their settings, see the "[List of Acoustic Piano Sound Setting Items](#)" (page EN-19).

3. After all the settings are the way you want, release **4** SOUND MODE.

■ List of Acoustic Piano Sound Setting Items

Setting	Available Options
<p>String Resonance Playing on an acoustic piano causes the strings that are harmonics of the played strings to resonate. You can select one of the string resonance settings in the column to the right.</p>	<p>Tone: Specifies the initial setting of each tone. Off: Disables String Resonance. 1 to 4: The greater the value, the stronger the String Resonance.</p>
<p>Damper Resonance Pressing the damper pedal on an acoustic piano opens all 88 of the strings, causing all of the strings that are harmonics of the strings that are played to resonate. You can select one of the damper resonance settings in the column to the right.</p>	<p>Tone: Specifies the initial setting of each tone. Off: Disables Damper Resonance. 1 to 4: The greater the value, the stronger the Damper Resonance.</p>
<p>Damper Noise Damper noise is a slight metallic ringing sound that is generated as the damper of an acoustic piano separates from the wires pedal when the damper pedal is pressed. You can use the settings in the column to the right to adjust the volume of the damper noise.</p>	<p>Tone: Specifies the initial setting of each tone. Off: Mutes Damper Noise. 1 to 4: The greater the value, the greater the noise volume.</p>
<p>Key On Action Noise When the keys of an acoustic piano are tapped with extremely light pressure, piano mechanism operation sound (noise) is produced without the hammers reaching the strings. You can use the settings in the column to the right to adjust the volume of the noise.</p>	<p>Tone: Specifies the initial setting of each tone. Off: Mutes Key On Action Noise. 1 to 4: The greater the value, the greater the noise volume.</p>
<p>Key Off Action Noise Releasing the keyboard keys of acoustic piano generates piano mechanism operation sound (noise). You can use the settings in the column to the right to adjust the volume of the noise.</p>	<p>Tone: Specifies the initial setting of each tone. Off: Key Off Action Noise muted. 1 to 4: The greater the value, the greater the noise volume.</p>

Using the Metronome

The metronome sounds a regular tone to mark time. Use the metronome when you want to practice playing at a regular tempo.

■ To start or stop the metronome

1. Touch **5** METRONOME.

This starts the metronome.

- LEDs above **6** ▶/■ button flash yellow (first beat) and red (remaining beats) in time with the metronome beats.
- You can specify metronome tempo, beat, and volume settings. Refer to the information below.

[Specifying the Tempo](#) (page EN-21)

[To change the metronome beat](#) (page EN-20)

[To adjust the metronome volume](#) (page EN-20)

2. To turn off the metronome, touch the **5** METRONOME again.

■ To change the metronome beat

1. While holding down **5** METRONOME, press a keyboard key from C2 through A2.



- The beat setting changes in accordance with the keyboard key you press, as shown in the table below.

Pressing this key:	Selects this setting:	Which does this:
C2	Off	Sounds a click for all beats.
C#2	1	Sounds a bell for all beats.
D2	2	These keys specify a beat setting of 2 to 9. The first beat of each measure is a bell sound, while the remaining beats are clicks.
E♭2	3	
E2	4	
F2	5	
F#2	6	
G2	7	
A♭2	8	
A2	9	

2. Release **5** METRONOME.

■ To adjust the metronome volume

1. While holding down **5** METRONOME, press the B♭1 or B1 keyboard key.

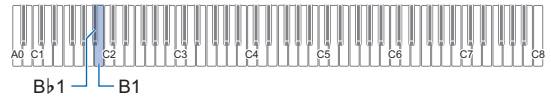

Pressing this key:	Does this:
B♭1	Lowers the metronome volume one level.
B1	Raises the metronome volume one level.
B♭1 + B1	Returns the metronome volume to its initial default setting.

- You can adjust the metronome volume within the range of 0 (muted) and 42 (maximum). As you use the B♭1 and B1 keyboard keys to change the setting, the reference tone (page EN-9) will sound any time the value becomes a multiple of 10 (10, 20, etc.)

2. Release **5** METRONOME.

Specifying the Tempo

When using the metronome (page EN-20) or when playing back a Music Library (page EN-24) song, you can specify a tempo setting within the range of 20 to 255 beats per minute. Use the keyboard keys below to specify the tempo setting value.

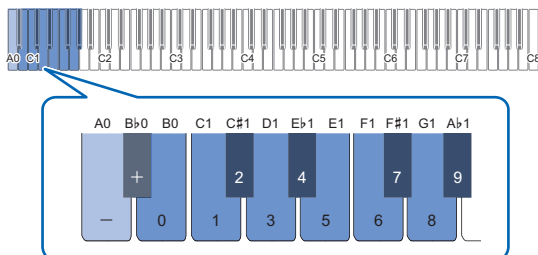

■ To input a tempo setting value

1. Hold down **5 METRONOME**.
 - Do not release **5 METRONOME** until step 3, below.
2. Use keyboard keys from **B0** to **A \flat 1** to input a tempo setting value.
 - Input three digits for the tempo value. To specify a value that has fewer than three digits, input zero (0) for the unused leading digit. For example, to specify a tempo of 80 bpm, press keyboard keys in the following sequence: B0 (0) → G1 (8) → B0 (0). The end tone (page EN-9) will sound when you input the third digit.
 - Here, you could use the A0 or B \flat 0 keyboard key to raise or lower the tempo by 1 with each press.
 - Pressing the A0 and B \flat 0 keyboard keys at the same time will return the tempo setting to the initial default value for the currently selected Music Library song (page EN-24).
3. After the setting is the way you want, release **5 METRONOME**.

■ To raise or lower the tempo setting value by one

1. While holding down **5 METRONOME**, press the **A0** or **B \flat 0** keyboard key as required.
 - Each press of the A0 keyboard key will raise the setting value by 1, while B \flat 0 lowers it by 1.
 - You can also use the keyboard keys from B0 to A \flat 1 to input a tempo value.
2. Release **5 METRONOME**.

NOTE

- You can also configure the setting of the pedal connected to the **12 DAMPER PEDAL** jack so pressing the pedal multiple times will cause the tempo value to change to match the speed of the pedal presses. See "Changing Pedal Functions" (page EN-33).

Splitting the Keyboard for Duet Play

You can split the keyboard in the center for duet play so the left and right sides have the same ranges.

The Duet Mode is the perfect way to conduct lessons, with the teacher playing on the left side as the student plays the same song on the right side.

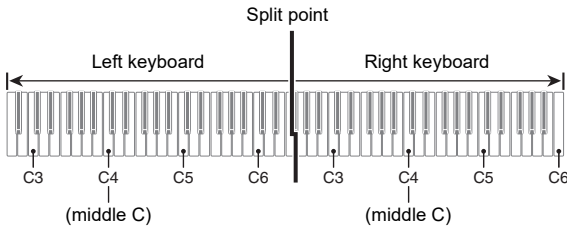

NOTE

- You can change the ranges of the left and right keyboards in octave units from their initial default settings. This comes in handy, for example, if the initial default range is not enough when one person is playing the left hand part and another person is playing the right hand part. For information about the setting operation, see [“To change the octaves of the duet keyboards”](#) (page EN-23).

■ Pedal Operation when Playing a Duet

- If you are using the separately available SP-34 Pedal Unit, the left outer pedal is the left keyboard damper pedal, while the right outer pedal is the right keyboard damper pedal. Only the damper pedal for the right keyboard supports half-pedal operations.

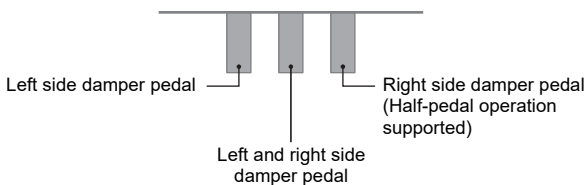

- To use the supplied SP-3 Pedal as a damper pedal that affects both the left keyboard and right keyboard, connect it to the **12 DAMPER PEDAL** jack. In the Duet Mode, this pedal functions as a damper pedal, regardless of the effect type assigned to it with the procedure under [“Changing Pedal Functions”](#) (page EN-33). Half-pedal operation is not supported in this case.

■ To use the Duet Mode

- While holding down **3 FUNCTION**, press the **C4** keyboard key.

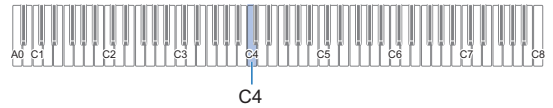

Each time the C4 keyboard key is pressed to change this setting, a notification tone sounds to indicate the newly selected setting.

Notification Tone*	Setting	Description
Off tone	Off	Duet Mode exited.
Option tone × 1	On	Duet Mode entered.
Option tone × 2	Pan	Left-side keyboard notes output from the left speaker, right-side keyboard notes output from the right speaker while in the Duet Mode.

* For more information, see [“Notification Tones”](#) (page EN-9).

- After the setting is the way you want, release **3 FUNCTION**.

NOTE

- Some settings become fixed and cannot be changed while in the Duet Mode.
- Hall Simulator (page EN-15), Surround (page EN-15) and Chorus (page EN-17) are disabled while the Duet Mode setting is “Pan”.

■ To change the octaves of the duet keyboards

1. Hold down **3** FUNCTION.
 - Do not release **3** FUNCTION until step 3, below.
2. Use the keyboard keys below to change the octaves of the left-side and right-side keyboards.

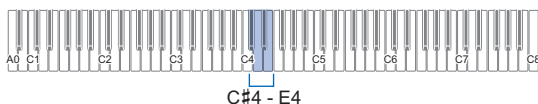

Pressing this key:	Does this:
C#4	Lowers the left-side keyboard one octave.
D4	Raises the left-side keyboard one octave.
C#4 + D4	Returns the range of the left-side keyboard to its initial default setting.
E♭4	Lowers the right-side keyboard one octave.
E4	Raises the right-side keyboard one octave.
E♭4 + E4	Returns the range of the right-side keyboard to its initial default setting.

- You can shift the octave of each keyboard within the range of -2 to +2 octaves.

Setting Example

Pressing the D4 keyboard key once will configure the keyboard octaves as shown below.

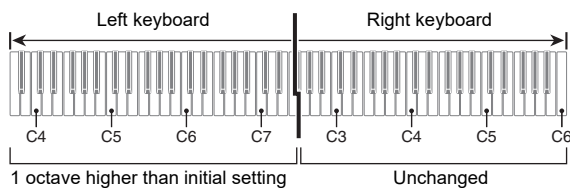

3. When the octave settings of the keyboards are the way you want, release **3** FUNCTION.

Changing the Scale Tuning (Temperament) of the Keyboard

You can change the scale of the keyboard from the standard equal temperament to another tuning that is more suitable for playing Indian music, Arabic music, classical music, etc. You can select from among the 17 preset scales described below.

■ To change the scale

1. While holding down **3** FUNCTION, press a keyboard key from G1 through B2.

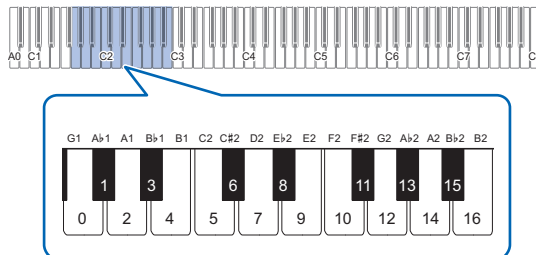

- Pressing a keyboard key changes to the applicable scale as shown in the table below.

Key	Setting Value	Scale Name
G1	0	Equal Temperament
A♭1	1	Pure Major
A1	2	Pure Minor
B♭1	3	Pythagorean
B1	4	Kirnberger 3
C2	5	Werckmeister
C#2	6	Mean-Tone
D2	7	Rast
E♭2	8	Bayati
E2	9	Hijaz
F2	10	Saba
F#2	11	Dashti
G2	12	Chahargah
A♭2	13	Segah
A2	14	Gurjari Todi
B♭2	15	Chandrakauns
B2	16	Charukeshi

2. Release **3** FUNCTION.

■ To specify the base note of the scale

1. While holding down **FUNCTION**, press a keyboard key from C3 through B3.

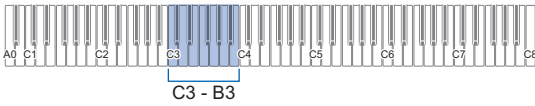

- The note of the keyboard key you press becomes the base note.

2. Release **FUNCTION**.

Listening to Songs (Music Library)

You can use the Music library for your listening enjoyment or to practice piano songs.

- The Music Library includes 60 songs, numbered 1 through 60.
- You can also transfer songs (user songs) from a smart device to the Digital Piano and save them as Music Library songs 61 through 70. User songs can also be used for playback and practice.

! IMPORTANT!

- Adding and deleting user songs can be performed only from a smart device connected to the Digital Piano. For more information, see “[Linking with a Smart Device \(APP Function\)](#)” (page EN-37).

■ To listen to Music Library songs

1. Select the song you want.

- (1) While holding down **6** **▶/■**, press one of the keyboard keys below.

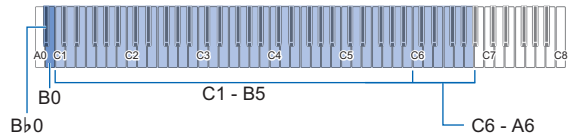

Pressing this key:	Does this:
C1 to B5	Selects the built-in song (Song numbers 1 to 60) that corresponds to the pressed keyboard key.
C6 to A6	Selects the user song (Song numbers 61 to 70) that corresponds to the pressed keyboard key.
B0	Selects the next song number.
Bb0	Selects the previous song number.

- For information about the song number assigned to each keyboard key, see “**▶/■** Button + Keyboard Key” in the separate “Keyboard Function List”. For a list of songs, see the “[Music Library List](#)” (page EN-43).

- (2) Release **6** **▶/■**.

2. To start song playback, touch **6** ▶/■.

- LEDs above the **6** ▶/■ button flash yellow (first beat) and red (remaining beats) in time with the metronome beats.
- Playback will stop automatically when the end of the song is reached. To stop song playback, touch **6** ▶/■.

NOTE

- Selecting a song in step 1 of the above procedure will automatically configure Digital Piano with settings that are appropriate for the selected song, and return the playback part (page EN-25) settings to their initial defaults.

■ To use a Music Library song for practice

NOTE

- You can turn off the left-hand part or right-hand part of a built-in song and play along on the keyboard.

1. Perform step 1 under “To listen to Music Library songs” (page EN-24) to select the song you want to practice.

2. As required, perform the procedure under “Specifying the Tempo” (page EN-21) to specify the tempo of the song.

- With some songs, the tempo will change part way through for the sake of performance expression.

3. Select the playback part (left-hand or right-hand part).

- (1) While holding down **6** ▶/■, press keyboard key A0 (leftmost white key).
Each press of the A0 keyboard key cycles through the settings shown below.
L only lit: Left-hand part played, right-hand part muted.
R only lit: Right-hand part played, left-hand part muted.
LR both lit: Both left- and right-hand parts played.
- (2) Release **6** ▶/■.

4. To start song playback, touch **6** ▶/■.

- Play the muted part along with the playback.
- You can also change the tempo setting during playback.
- Playback will stop automatically when the end of the song is reached. To stop song playback, touch **6** ▶/■.

Recording and Playing Back Performances (MIDI Recorder)

Your Digital Piano can record what you play on the keyboard and play it back when you want.

IMPORTANT!

- **CASIO COMPUTER CO., LTD. takes no responsibility for any damages, lost profits, or claims by third parties arising from the deletion of recorded data due to malfunction, repair, or for any other reason.**

■ How the Digital Piano records your performances (MIDI Recorder)

Your Digital Piano uses a MIDI recorder (not an audio recorder) to record your performances. It records keyboard performance information (keyboard key press and release, touch pressure, etc.) as MIDI data.*

- One recorded song can be in memory at a time. Starting a new recording deletes any data that was previously recorded in memory.
- The left track and right track can be recorded individually and combined into a single song.

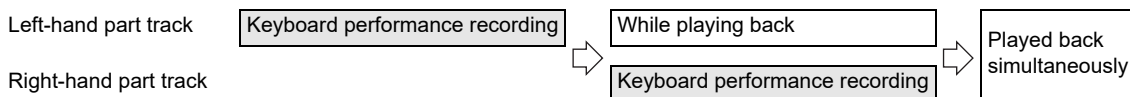

- Up to approximately 10,000 notes (total of two tracks) can be recorded for a single song.

* MIDI

MIDI is short for "Musical Instrument Digital Interface". It is a universal standard that makes it possible for musical instruments, computers, and other devices to exchange performance information (keyboard key press/release, touch pressure, etc.) regardless of manufacturer. Performance data in this case is called "MIDI data".

NOTE

- MIDI data stored in Digital Piano memory cannot be saved to a USB flash drive, a computer, or any other external device.

■ Recorded MIDI Data

Recording with the MIDI recorder also records the operations and settings below in Digital Piano memory.

- Keyboard play and pedal operations
- Tone
- Tempo*
- Beat*
- Layer setting (Left-hand part track only)
- Split setting (Left-hand part track only)
- Duet (Left-hand part track only)
- Sound Mode (Hall Simulator type, Hall Simulator depth applied to the Digital Piano sound source, and Surround type), Chorus, Brilliance*
- Acoustic simulator setting*
- Scale*

* Common for both tracks. Settings configured for the left-hand part track are also applied to the right-hand part track.

Creating a Recording

IMPORTANT!

- If, during a recording operation, the number of remaining recordable notes is 100 or fewer, the indicator of the track being recorded (L or R) will start to flash more quickly. Recording stops automatically when the number of remaining recordable notes becomes 0.
- Should power fail during recording, all of the data in the track you are recording will be deleted.
- You cannot use keyboard operations to configure settings while in record standby or while recording is in progress.

■ Quick Guide: Simplest performance recording operation

1. While the **7** ● (REC) button is lit white, touch **7** ● (REC).
This enters record standby, which is indicated by flashing **7** ● (REC) (red) and **6** ▶/■ (white) lights.
2. To start recording, play something on the keyboard.
This causes the **7** ● (REC) (red) light to change from flashing to lit, which indicates that recording is in progress.
3. When you are finished recording, touch **7** ● (REC) or **6** ▶/■.
This makes **7** ● (REC) light white again.
4. To replay the recording, touch **6** ▶/■.

NOTE

- The above operation records what is played on the keyboard to the left-hand part track. For further operation details, see “To record the left-hand part track” (page EN-27).

■ To record the left-hand part track

1. Depending on the track to be recorded, configure the applicable settings.
 - See “Recorded MIDI Data” (page EN-26).
 - If you want to specify a beat and tempo setting, refer to the information below and configure the settings.
 - “To change the metronome beat” (page EN-20)
 - “Specifying the Tempo” (page EN-21)
2. While the **7** ● (REC) button is lit white, touch **7** ● (REC).
This enters record standby, which is indicated by flashing **7** ● (REC) (red) and **6** ▶/■ (white) lights.
 - At this time, the “L” indicator starts to flash. This indicates that the left-hand part track will be recorded.
 - To exit a recording operation here, touch **7** ● (REC). This makes **7** ● (REC) light white again.
3. If you want the metronome to sound during recording, touch **5** METRONOME.
4. To start recording, play something on the keyboard, press the pedal or touch **6** ▶/■.
This causes the **7** ● (REC) light (red) to change from flashing to lit.
5. When you are finished recording, touch **7** ● (REC) or **6** ▶/■.
This makes **7** ● (REC) light white again.
6. To replay the recording, touch **6** ▶/■.

NOTE

Restarting Recording From the Beginning

- If you make a mistake and want to stop an ongoing recording operation and restart recording from the beginning, hold down **7** ● (REC) until its light flashes. This discards everything you have recorded to the left-hand track and returns to record standby. Perform the operation from step 4 of the above procedure to restart recording.

■ To overdub a left-hand part track recording with right-hand part track recording

1. Perform steps 1 and 2 under “To record the left-hand part track” (page EN-27).
2. Press **7** ● (REC) as many times as necessary until the “R” and “L” indicators are as described below.
 - “R” indicator flashing. This indicates that the right-hand part track will be recorded.
 - The “L” indicator stops flashing. This indicates that the left-hand part track recording is complete.
3. As required, specify whether or not you want to play back the left-hand track while recording.
 - (1) While holding down **6** ▶/■, press keyboard key A0 (leftmost white key). Each press of the A0 keyboard key toggles the “L” indicator between lit and unlit.
 - L lit: Left-hand part track playback during recording.
 - L unlit: No left-hand part track playback during recording.
 - (2) Release **6** ▶/■.
4. If you want the metronome to sound during recording, touch **5** METRONOME.
5. To start recording, play something on the keyboard, press the pedal or touch **6** ▶/■. This causes the **7** ● (REC) light (red) to change from flashing to lit.
 - The settings configured for the left-hand part track are applied for the beat and tempo.
6. Perform the procedure starting from step 5 under “To record the left-hand part track” (page EN-27).

NOTE

Restarting Overdubbing From the Beginning

- If you make a mistake and want to stop an ongoing overdubbing operation and restart overdubbing from the beginning, hold down **7** ● (REC) until its light flashes. This discards everything you have recorded to the right-hand track and returns to record standby. Perform the operation from step 5 of the above procedure to restart overdubbing.

■ To delete everything recorded to a track

1. While the **7** ● (REC) button is lit white, touch **7** ● (REC). This enters record standby, which is indicated by flashing **7** ● (REC) (red) and **6** ▶/■ (white) lights.
 - At this time, the “L” indicator is flashing. If you want to delete the contents of the left-hand part track, advance directly to step 3.
2. If you want to delete the contents of the right-hand part track, hold down **7** ● (REC) until the “R” indicator starts to flash.
3. Touch **6** ▶/■. This causes the **7** ● (REC) light (red) to change from flashing to lit.
4. Hold down **7** ● (REC) until its light flashes. This deletes the contents of the specified track.
5. Touch **7** ● (REC) to exit record standby.

Playing Back Recorded Content

Immediately after finishing a recording, touching **6** ▶/■ will play it back. Use the procedure below to play back a recording if you played a Music Library song or turned off Digital Piano power after recording it.

■ To perform playback

1. While holding down **6** ▶/■, press the C7 keyboard key.

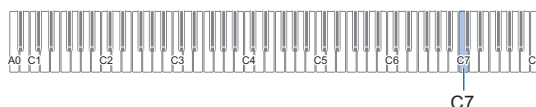

2. Release **6** ▶/■.
3. To start playback, touch **6** ▶/■.
 - Playback will stop automatically when the end of the recording is reached. To stop playback manually, touch **6** ▶/■.

Configuring Settings

Adjusting the Upper1 Part Volume

To adjust the Upper1 part volume, hold down **8 GRAND PIANO** as you press the keyboard keys shown below.

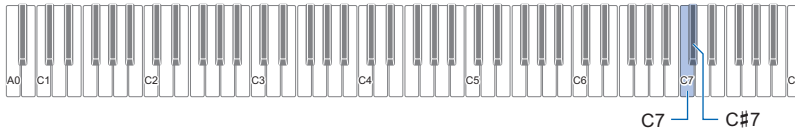

Pressing this key:	Does this:
C7	Lowers the Upper1 part volume by 1.* ¹
C#7	Raises the Upper1 part volume by 1.* ¹
C7 + C#7	Returns the volume of the Upper1 part to the initial default setting.

*1 You can set the volume within the range of 0 to 42. The reference tone (page [EN-9](#)) will sound any time the setting value becomes a multiple of 10 (10, 20, etc.)

Configuring Upper2 Part and Lower Part Settings

You can configure separate Upper2 and Lower (bass) part settings for the following items: volume, pitch, damper pedal effect enable/disable. To configure these settings, hold down **9 ELEC. PIANO** as you press the keyboard keys shown below.

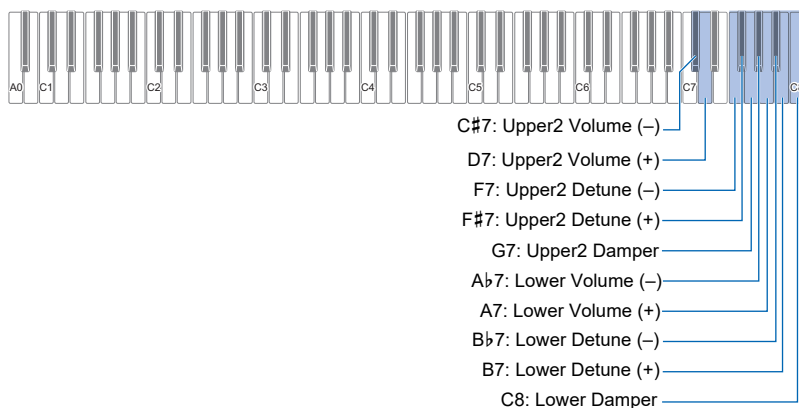

Setting	Pressing this key:	Does this:
Upper2 Volume Adjusts the volume of the Upper2 part.	C#7	Lowers the Upper2 part volume by 1.*1*2
	D7	Raises the Upper2 part volume by 1.*1*2
	C#7 + D7	Returns the volume of the Upper2 part to the initial default setting.
Upper2 Detune Raises or lowers the pitch of the Upper2 part, relative to the Upper1 part, within the range of ±99 cents	F7	Lowers the pitch of the Upper2 part one cent.*2
	F#7	Raises the pitch of the Upper2 part one cent.*2
	F7 + F#7	Makes the pitch of the Upper2 part identical to the pitch of the Upper1 part (default).
Upper2 Damper Toggles application of the damper pedal effect to the Upper2 part between enabled and disabled.	G7	Toggles between enabled and disabled.
Lower Volume Specifies the Lower part volume.	Ab7	Lowers the Lower part volume by 1.*1*2
	A7	Raises the Lower part volume by 1.*1*2
	Ab7 + A7	Returns the Lower part volume to the initial default setting.
Lower Detune Raises or lowers the pitch of the Lower part, relative to the Upper1 part, within the range of ±99 cents.	Bb7	Lowers the pitch of the Lower part one cent.*2
	B7	Raises the pitch of the Lower part one cent.*2
	Bb7 + B7	Makes the pitch of the Lower part identical to the pitch of the Upper1 part (default).
Lower Damper Toggles application of the damper pedal effect to the Lower part between enabled and disabled.	C8	Toggles between enabled and disabled.

*1 You can set the volume within the range of 0 to 42.

*2 The reference tone (page EN-9) will sound any time the setting value becomes a multiple of 10 (10, 20, etc.)

Adjusting the Volume Balance

You can use the keyboard keys in this section to adjust the volumes of keyboard play, song playback, and externally input audio. To adjust, hold down **F3 FUNCTION** as you press the keyboard keys shown below.

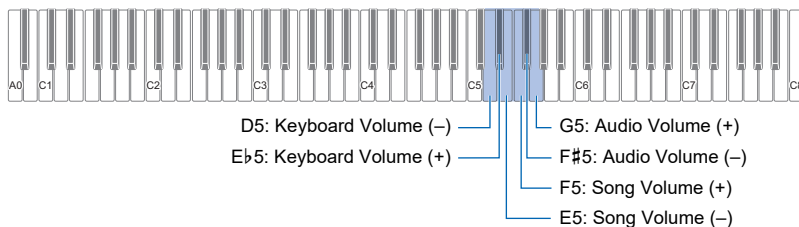

Setting	Pressing this key:	Does this:
Keyboard Volume The overall volume of keyboard play can be adjusted within the range of 0 (muted) to 42 (maximum).	D5	Lowers the keyboard volume by 1.*1
	E♭5	Raises the keyboard volume by 1.*1
	D5 + E♭5	Returns the keyboard volume to its initial default setting.
Song Volume The overall volume of song (built-in songs, user songs, MIDI recorder songs) playback can be adjusted within the range of 0 (muted) to 42 (maximum).	E5	Lowers the song volume by 1.*1
	F5	Raises the song volume by 1.*1
	E5 + F5	Returns the song volume to its initial default setting.
Audio Volume The overall volume of externally input audio*2 can be adjusted within the range of 0 (muted) to 42 (maximum).	F#5	Lowers the audio volume by 1.*1
	G5	Raises the audio volume by 1.*1
	F#5 + G5	Returns the audio volume to its initial default setting.

*1 The reference tone (page EN-9) will sound any time the setting value becomes a multiple of 10 (10, 20, etc.)

*2 Audio input from a Bluetooth connected smart device or an audio device connected to the Digital Piano's **F14 AUDIO IN** jack.

Audio-In Center Cancel

Enabling Audio-In Center Cancel cuts the vocal part from the audio being input using Bluetooth or the Digital Piano's **F14 AUDIO IN** jack. Note that this function cancels the sound in the center position of the audio, which may (depending on how the original audio was mixed) end up canceling something else other than the vocal part. How vocal cut is performed depends on the sound being input.

To change Audio-In Center Cancel setting, hold down **F3 FUNCTION** as you press the keyboard key shown below. Each press toggles between enabled and disabled.

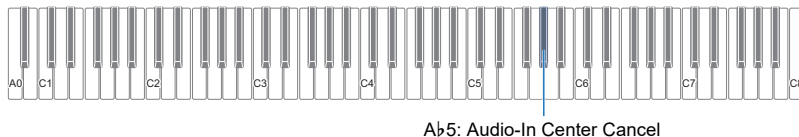

Configuring MIDI Settings

To change MIDI settings, hold down **FUNCTION** as you press the keyboard keys shown below.

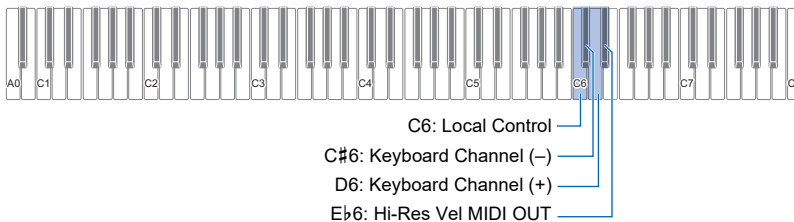

Setting	Pressing this key:	Does this:
Local Control When this setting is turned off, performance information (MIDI data) is sent from the Digital Piano, but no Digital Piano sound is output. This setting is for when you only want to send MIDI data to an external device.	C6	Toggles between on and off.
Keyboard Channel This setting specifies a channel from 1 through 16 as the MIDI channel that can be used for sending data to an external device.	C#6	Lowers the Keyboard Channel by 1.
	D6	Raises the Keyboard Channel by 1.
	C#6 + D6	Returns the Keyboard Channel to its initial default setting (1).
Hi-Reso Velocity MIDI Out This setting enables/disables high-resolution MIDI output of touch pressure (velocity) when keyboard keys are pressed.	E♭6	Toggles between enabled and disabled.

Changing Pedal Functions

A pedal connected to the Digital Piano's **12 DAMPER PEDAL** jack functions as a damper pedal under initial Digital Piano default settings. You can use the procedure below to change the pedal to another function.

■ To change the function of the pedal connected to the **DAMPER PEDAL** jack.

1. Hold down **3 FUNCTION**.

- Do not release **3 FUNCTION** until step 3, below.

2. Press the E6 keyboard key.

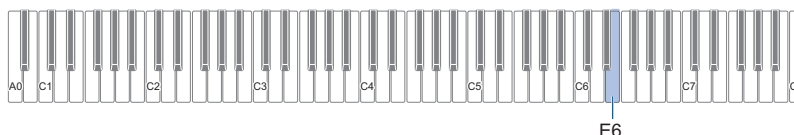

Each time the E6 keyboard key is pressed to change this setting, a notification tone sounds to indicate the newly selected setting.

Notification Tone Count	With this setting:	The pedal does this:
1	Damper	Sustains notes played while the pedal is depressed, even if the keyboard key is subsequently released. Organ and other tones that are sustained as long as keyboard key are depressed continue to sound as long as the pedal is depressed.
2	Sostenuto	Only the notes of the keys that are depressed when the pedal is pressed are sustained, even if the keyboard keys are released, until the pedal is released.
3	Soft	Slightly lowers and softens notes played while the pedal is depressed.
4	Metronome	Starts and stops the metronome.
5	Tempo setting	Pressing the pedal multiple times will cause the tempo value to change to match the timing of the pedal presses.

3. After the setting is the way you want, release **3 FUNCTION**.

Other Settings

To change settings shown in the table below, hold down **F3 FUNCTION** as you press the indicated keyboard keys.

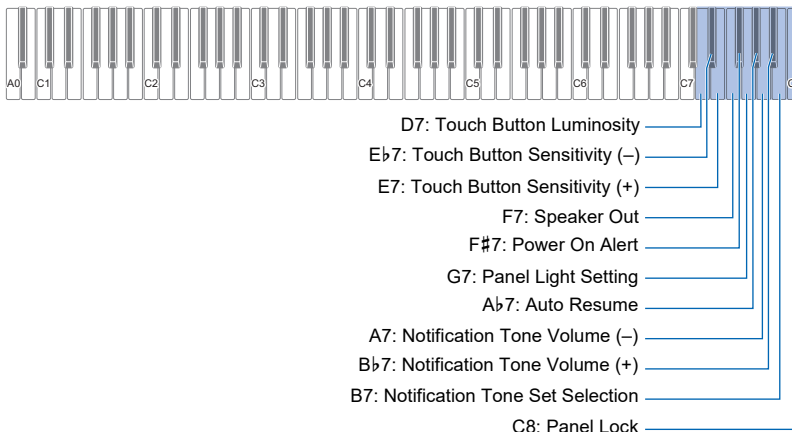

Setting	Pressing this key:	Does this:
Touch Button Luminosity Toggles the touch button luminosity setting between 1 (dim) and 2 (bright).	D7	Toggles the setting between 1 and 2.
Touch Button Sensitivity Specifies touch button sensitivity within the range of -1 (Low) to 0 (Standard) to +1 (High).	E♭7	Lowers the touch button sensitivity setting by 1.
	E7	Raises the touch button sensitivity setting by 1.
Speaker Out Controls whether or not sound is output from the speakers when something is plugged into either of the F10 PHONES jacks. Sound is not output when this setting is disabled (default), and output when it is enabled.	F7	Toggles between enabled and disabled.
Power On Alert Enables or disables Power On Alert (page EN-7).	F#7	Toggles between enabled and disabled.
Panel Light Setting To save power, you can configure a setting that will turn off all button lights, except for F3 FUNCTION , after a certain period of non-operation. You can specify a trigger time of 5, 30, 60, or 120 seconds. You can also disable this setting, which means that lights will remain on.	G7	See “To change the panel light setting” (page EN-35).
Auto Resume Enabling Auto Resume causes most settings to be saved while power is turned off.*1	A♭7	Toggles between enabled and disabled.
Notification Tone Volume The notification tone volume can be adjusted within the range of 0 (muted) to 10 (maximum).	A7	Lowers the notification tone volume by 1.
	B♭7	Raises the notification tone volume by 1.
	A7 + B♭7	Returns the notification tone volume to its initial default setting.
Notification Tone Set Selection Your Digital Piano lets you know the results of operations by sounding notification tones. You can select from among three different notification tone sets.	B7	Cycles the setting to the next notification tone set (1, 2, 3).

Setting	Pressing this key:	Does this:
Panel Lock While this setting is enabled, the lights of all touch buttons, except F3 FUNCTION , are turned off, and all operations are disabled, except for those below. <ul style="list-style-type: none"> • F1 (Power) button power operations. Turning off Digital Piano power cancels panel lock. • Touch button operation to cancel Panel Lock. 	C8	Toggles between enabled and disabled. To cancel Panel Lock, hold down F3 FUNCTION as you press the C8 keyboard key.

*1 The settings below are not retained even if Auto Resume is enabled.
 Duet Mode setting, song playback part setting, Local Control, Panel Lock

■ To change the panel light setting

1. Hold down **F3 FUNCTION**.

- Do not release **F3 FUNCTION** until step 3, below.

2. Press the G7 keyboard key.

Each time the G7 keyboard key is pressed to change this setting, a notification tone sounds to indicate the newly selected setting.

Notification Tone*	Setting	Description
Off tone	Off	Touch button lights remain lit.
Option tone × 1	5 seconds	After non-operation of the front panel for the specified time, the lights of all touch buttons, except for F3 FUNCTION , will turn off.
Option tone × 2	30 seconds	
Option tone × 3	60 seconds	
Option tone × 4	120 seconds	

* For more information, see “Notification Tones” (page EN-9).

3. After the setting is the way you want, release **F3 FUNCTION**.

NOTE

- Turning on the Digital Piano under battery power only (without AC adaptor power) will cause the Panel Light Setting to change automatically to 60 seconds to conserve power. You can change the Panel Light Setting if you want.

Factory Reset (Initialization)

You can use the procedure below to return the Digital Piano's stored data and settings to their initial factory defaults any time you want.

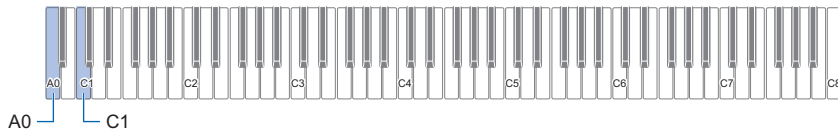

1. Hold down **3 FUNCTION.**

2. Press the A0 keyboard key.

This enters factory reset standby and causes the **3** FUNCTION light to flash.

- Step 3 below will execute the initialization operation. If you want to cancel initialization at this point, release **3** FUNCTION.

3. To execute initialization, press the C1 keyboard key.

This starts initialization.

4. Release **3 FUNCTION.**

- The initialization operations takes some time to complete. Wait until initialization is complete. All front panel touch button lights (**3** FUNCTION to **9** ELEC. PIANO) light when initialization is complete.

Linking with a Smart Device (APP Function)

You can use the APP Function to connect the Digital Piano with a phone, tablet or other smart device and perform the operations described below.

- Control the Digital Piano from a smart device (Piano Remote Controller)
- Transfer music data from a smart device

IMPORTANT!

- Put the mobile device you will connect with into its Airplane Mode or otherwise disable device communications.
- When connecting a smart device to the Digital Piano, do not connect both a USB cable and an audio cable at the same time.

■ To download the smart device app

Download the Chordana Play for Piano app from the CASIO website and install it on the smart device.

<https://support.casio.com/global/en/emi/manual/PX-S1000/>



■ To link to a smart device

1. Referring to “[To download the smart device app](#)” (page [EN-37](#)), install the app on the smart device.
2. Use a commercially available USB cable to connect the smart device USB port to the Digital Piano  **USB port.**
 - After connecting the smart device to the Digital Piano, use the smart device app to perform operations. For details about operations, refer to the user documentation of the app.

Troubleshooting

● Nothing happens when I touch a touch button.

Cause:

- Wearing glove or touching with a fingernail or stylus.
- Incorrect touch button sensitivity setting.

Action:

- When operating a touch button, touch it firmly with a bare finger.
- Perform the steps below to increase touch button sensitivity.
 - Turn off the Digital Piano.
 - While holding down the C8 keyboard key (the one on the far right), press the **1** **⏻** (Power) button.
 - Keep the C8 keyboard depressed until the touch buttons start to light in sequence from left to right (from **3** **FUNCTION** to **9** **ELEC. PIANO**). You do not need to keep the **1** **⏻** (Power) button depressed.

● No sound is produced when I press a keyboard key.

Cause:

- The **2** volume knob setting is too low.
- Headphones or an adaptor plug is plugged into one of the **10** **PHONES** jacks.
- MIDI Local control is turned off.

Action:

- Rotate the **2** volume knob.
- Disconnect whatever is connected to the **10** **PHONES** jacks.
- Turn on the Local control setting (page [EN-32](#)).

● The Digital Piano emits a loud sound and suddenly turns off.

Action:

Replace the batteries with new ones or switch over to AC adaptor power (page [EN-5](#)).

● The pitch of the Digital Piano is off.

Cause:

- The current transpose setting of the keyboard is something other than the default setting.
- The Digital Piano's tuning setting is something other than "440.0Hz".
- Octave shift is enabled.
- The current scale setting is something other than "Equal Temperament".

Action:

- Return transpose (page [EN-13](#)) to its initial default setting.
- Change the tuning setting to "440.0Hz" (page [EN-14](#)), and return Upper2 Detune and Lower Detune (page [EN-30](#)) to their default settings.
- Change the octave shift setting to 0 (page [EN-14](#)).
- Change the scale setting to "Equal Temperament".

● Nothing happens when I press a pedal.

Cause:

The pedal cord is not connected correctly to the **12** **DAMPER PEDAL** jack or **13** **PEDAL UNIT** jack, or the plug is not plugged in completely.

Action:

Confirm that the pedal cord is connected correctly, and that the plug is inserted as far as it will go.

● Tones and/or effects sound strange. Note intensity does not change even though I alter key pressure. Turning power off and then back on again does not eliminate the problem.

Cause:

Auto Resume is enabled.

Action:

Disable Auto Resume (page [EN-34](#)) and turn off power.

● I cannot transfer data after connecting the Digital Piano to a computer.

Action:

- Check to make sure that the USB cable is connected to the Digital Piano and computer, and that the correct device is selected with your computer's music software.
- Turn off the Digital Piano and then exit the music software on your computer. Next, turn the Digital Piano back on and then restart the music software on your computer.

● A tone's quality and volume sounds slightly different depending where it is played on the keyboard.

Cause:

This is an unavoidable result of the digital sampling process,* and does not indicate malfunction.
* Multiple digital samples are taken for the low range, middle range, and high range of the original musical instrument. Because of this, there may be very slight differences in tonal quality and volume between sample ranges.

- **Touching a button causes the note that is sounding cuts out momentarily or a slight change in how effects are applied.**
-

Cause:

This happens when the sounds of multiple parts are sounding at the same time while using layer, using the Duet Mode, playing back a built-in song, recording, etc. Pressing a button when one of these conditions exists will cause the effect setting that is built into the tone to change automatically, which causes notes to cut out momentarily or causes a slight change in how effects are being applied.

- **How do I delete a user song?**
-

Action:

Adding and deleting user songs can be performed only from a smart device connected to the Digital Piano. For more information, see "[Linking with a Smart Device \(APP Function\)](#)" (page EN-37).

Reference

Product Specifications

Model	PX-S1000BK/PX-S1000WE/PX-S1000RD
Keyboard	88-key piano keyboard
Duet	Adjustable tone range (-2 to +2 octaves)
Transpose	-12 to 0 to +12 semitones
Octave shift	-2 to 0 to +2 octaves
Sound Source	
Number of Tones	18 (17 full-keyboard tones + 1 low-range bass tone) • Layer (excluding bass tone) • Split (bass tone only in low range)
Maximum polyphony	192 notes
Touch Response	5 sensitivity levels, Off
Tuning	415.5Hz to 440.0Hz to 465.9Hz (0.1Hz units)
Temperament	Equal temperaments plus 16 other types
Acoustic Simulator	Hammer response, Key off response, String resonance, Damper resonance, Damper noise, Key on action noise, Key off action noise
Digital Effect	
Sound Mode	Hall simulator (4 types), Surround (2 types)
Other Effects	Chorus (4 types), DSP (Preset for some tones), Brilliance (-3 to 0 to +3)
Demo Song	1
Music Library	
Built-in Songs	60
User Songs	10 (Up to approximately 90KB per song, approximately 900KB for 10 songs)* * Based on 1KB = 1024 bytes, 1MB = 1024 ² bytes
Song volume	Adjustable (Setting also affects MIDI recorder song playback.)
Part On/Off	L, R
MIDI Recorder	
Functions	Real-time recording, playback
Number of Song	1
Number of Tracks	2
Capacity	Approximately 10,000 notes total
Recorded Data Protection	Built-in flash memory
MIDI recorder volume	Adjustable (Setting also affects Music Library song playback.)
Metronome	
Beat bell	Off, 1 to 9 (beats)
Tempo Range	20 to 255
Metronome Volume Level	Adjustable
Pedals	
Included SP-3 pedal assignable functions	Damper (off, on), sostenuto (off, on), soft (off, on), metronome (start, stop), tempo setting
Separately available SP-34 pedal unit	Damper (off, half, on), sostenuto (off, on), soft (off, on)
Other Functions	<ul style="list-style-type: none"> • Auto Resume • Panel Lock • Notification tones (Selectable sets 1, 2, 3; Adjustable volume)
Bluetooth Connection	
Bluetooth Version	5.0
Supported Profile	A2DP
Supported Codecs	SBC
Wireless Output	Bluetooth Class 2
Transmission Frequency Range	2402 to 2480 MHz
Maximum Wireless Output	4 dBm
MIDI	16-channel multi-timbre receive

Inputs/Outputs	
PHONES jacks	Stereo mini jacks (3.5mm) × 2
Power	12V DC
AUDIO IN jack	Stereo mini jack (3.5mm) Input impedance: 10kΩ Input voltage: 200mV
LINE OUT R, L/MONO jacks	Standard jacks (6.3mm) × 2 Output impedance: 2.3kΩ Output voltage: 1.3V (RMS) MAX
USB port	Type B
DAMPER PEDAL jack	Standard jack (6.3mm)
PEDAL UNIT jack	Proprietary jack
Acoustics	
Amp output	8W + 8W
Speakers	16cm × 8cm (oval) × 2
Power Supply	
Batteries	2-way 6 AA-size alkaline batteries Continuous Operation: Approximately 4 hours Playback of built-in demo tunes on alkaline batteries Actual continuous operation time may be shorter due to battery type and performance type.
AC Adaptor	AD-A12150LW
Auto Power Off	Approximately four hours (under AC adaptor power) or six minutes (under battery power) after last operation; Can be disabled.
Power Consumption	12V --- 10W
Dimensions	132.2 (W) × 23.2 (D) × 10.2 (H) cm (52 1/16 × 9 1/8 × 4 inch)
Weight	Approximately 11.2kg (24.7 lbs) (without batteries)

- Specifications and designs are subject to change without notice.

Tone List

Tone Name	Keyboard Key Note Name	Program Change	Bank Select MSB
GRAND PIANO CONCERT	A0	0	0
GRAND PIANO BRIGHT	Bb0	1	0
GRAND PIANO MELLOW	B0	2	0
ROCK PIANO	C1	3	0
JAZZ PIANO	C#1	4	0
ELEC.PIANO	D1	5	0
DIGITAL E.PIANO 1	Eb1	6	0
DIGITAL E.PIANO 2	E1	7	0
60'S E.PIANO	F1	8	0
HARPSICHORD	F#1	9	0
VIBRAPHONE	G1	10	0
STRINGS 1	Ab1	11	0
STRINGS 2	A1	12	0
PIPE ORGAN	Bb1	13	0
JAZZ ORGAN	B1	14	0
ELEC.ORGAN 1	C2	15	0
ELEC.ORGAN 2	C#2	16	0
BASS	D2	17	0

NOTE

- The BASS tone can be assigned to the low range of the keyboard only. It cannot be used alone across the full keyboard range.

Music Library List

No.	*1	Title
1	C1	Nocturne Op.9-2
2	C#1	Fantaisie-Impromptu Op.66
3	D1	Étude Op.10-3 "Chanson de l'adieu"
4	E♭1	Étude Op.10-5 "Black Keys"
5	E1	Étude Op.10-12 "Revolutionary"
6	F1	Étude Op.25-9 "Butterflies"
7	F#1	Prélude Op.28-7
8	G1	Valse Op.64-1 "Petit Chien"
9	A♭1	Valse Op.64-2
10	A1	Moments Musicaux 3
11	B♭1	Impromptu Op.90-2
12	B1	Marche Militaire 1 (Duet)
13	C2	Frühlingslied [Lieder Ohne Worte Heft 5]
14	C#2	Fröhlicher Landmann [Album für die Jugend]
15	D2	Von fremden Ländern und Menschen [Kinderszenen]
16	E♭2	Träumerei [Kinderszenen]
17	E2	Tambourin
18	F2	Menuet BWV Anh.114 [Clavierbüchlein der Anna Magdalena Bach]
19	F#2	Inventio 1 BWV 772
20	G2	Inventio 8 BWV 779
21	A♭2	Inventio 13 BWV 784
22	A2	Praeludium 1 BWV 846 [Das Wohltemperierte Klavier 1]
23	B♭2	Le Coucou
24	B2	Gavotte
25	C3	Sonatina Op.36-1 1st Mov.
26	C#3	Sonatine Op.20-1 1st Mov.
27	D3	Sonate K.545 1st Mov.
28	E♭3	Sonate K.331 3rd Mov. "Turkish March"
29	E3	Rondo K.485
30	F3	Für Elise
31	F#3	Marcia alla Turca
32	G3	Sonate Op.13 "Pathétique" 1st Mov.
33	A♭3	Sonate Op.13 "Pathétique" 2nd Mov.
34	A3	Sonate Op.13 "Pathétique" 3rd Mov.
35	B♭3	Sonate Op.27-2 "Moonlight" 1st Mov.
36	B3	Rhapsodie 2
37	C4	Waltz Op.39-15 (Duet)
38	C#4	Liebesträume 3
39	D4	Blumenlied
40	E♭4	La Prière d'une Vierge
41	E4	Csikos Post
42	F4	Humoresque Op.101-7
43	F#4	Melodie [Lyrische Stücke Heft 2]
44	G4	Sicilienne Op.78
45	A♭4	Berceuse [Dolly] (Duet)
46	A4	Arabesque 1
47	B♭4	La Fille aux Cheveux de Lin [Préludes]

No.	*1	Title
48	B4	Passepied [Suite bergamasque]
49	C5	Gymnopédie 1
50	C#5	Je Te Veux
51	D5	Salut d'Amour
52	E♭5	The Entertainer
53	E5	Maple Leaf Rag
54	F5	L'arabesque [25 Étüden Op.100]
55	F#5	La Styrienne [25 Étüden Op.100]
56	G5	Ave Maria [25 Étüden Op.100]
57	A♭5	Le retour [25 Étüden Op.100]
58	A5	La chevaleresque [25 Étüden Op.100]
59	B♭5	No.13 [Études de Mécanisme Op.849]
60	B5	No.26 [Études de Mécanisme Op.849]

*1 Keyboard Key Note Name

MIDI Implementation Chart

Function	Transmitted	Recognized	Remarks
Basic Channel Default Changed	1 - 16 1 - 16	1 - 16 1 - 16	
Mode Default Messages Altered	Mode 3 X * * * * * * * * * *	Mode 3 X * * * * * * * * * *	
Note Number True Voice	12 - 120 * * * * * * * * * *	0 - 127 0 - 127	
Velocity Note ON Note OFF	0 9nH v = 1 - 127 0 8nH v = 0 - 127	0 9nH v = 1 - 127 0 8nH v = 0 - 127, 9nH v = 0	
After Touch Key's Ch's	X X	X O	
Pitch Bender	X	O	
Control Change 0 1 5 6, 38 10 11 64 65 66 71 72 73	O X X O *1 O X *4 O X *4 X O *2 X O *2 X O *4 X *4 X *4	O O O *1 O O O O O O O O O O O O O	Bank select Modulation Portamento time Portamento Destiny LSB, MSB Volume Pan Expression Hold 1 Portamento switch Sostenuto Soft pedal Foot pedal Release time Attack time

74 76 77 78 84 86 87 93 94 100, 101	X *4 X X X X O *3 X *4 X *4 X *4 X *4 X *1	Filter cutoff Vibrato rate Vibrato depth Vibrato delay Portamento control High resolution velocity prefix Pitch bend sensitivity Chorus send level Delay send level RPN LSB, MSB	O O O O O O O O O O *1
Program Change : True #	O * * * * * * * * * *	O 0 - 127	O 0 - 127
System Exclusive	O *1	O *1	O *1
System Common : Song Pos : Song Sel : Tune	X X X	X X X	X X X
System Real Time : Clock : Commands	X X	X X	X X
Aux Messages : All Sound Off : Reset All Controller : Local ON/OFF : All Notes OFF : Active Sense : System Reset	X *4 X *4 X X *4 O X	O O X O O X	O *1 O *1 X X O O X
Notes	*1: For details about RPN and system exclusive messages, see MIDI Implementation at https://world.casio.com/ . *2: Depends on the setup of the pedal connected to the DAMPER PEDAL jack. *3: Note ON only *4: Output along with certain operations.		

Mode 1 : OMNI ON, POLY
Mode 3 : OMNI OFF, POLY

Mode 2 : OMNI ON, MONO
Mode 4 : OMNI OFF, MONO

O : Yes
X : No

CASIO®

CASIO COMPUTER CO., LTD.
6-2, Hon-machi 1-chome
Shibuya-ku, Tokyo 151-8543, Japan

PXS1000-E-2B

MA1908-B

© 2019 CASIO COMPUTER CO., LTD.