

# SAFETY INFORMATION SHEET

## WARNING

**INSTALLATION OF THIS PRODUCT NEAR POWER LINES IS DANGEROUS. FOR YOUR SAFETY, FOLLOW THE ENCLOSED INSTALLATION DIRECTIONS.**

### HOW TO INSTALL YOUR OUTDOOR ANTENNA SAFELY IN ACCORDANCE WITH THE RECOMMENDATIONS OF THE U.S. CONSUMER PRODUCT SAFETY COMMISSION

*These safety recommendations apply to all SIRIO commercial, amateur and general purpose communication antennas. SIRIO antenna assumes no liability if faulty or dangerous installation practices are used. There are available, trained and experienced personnel to assist in installation, maintenance, or disassembly. Contact your local installer if consultation or assistance is required.*

### YOU, YOUR ANTENNA, AND SAFETY

Each year hundreds of people are killed, mutilated or receive severe permanent injuries when attempting to install an antenna. In many of these cases, the victim was aware of the danger of electrocution, but did not take adequate steps to avoid the hazard.

For your safety, and to help you achieve a good installation, please **READ** and **FOLLOW** the safety precautions below. **THEY MAY SAVE YOUR LIFE!**

1. If you are installing an antenna for the first time, please, for your own safety as well as others, seek **PROFESSIONAL ASSISTANCE**. Consult your dealer. He can explain which mounting method to use for the size and type antenna you are about to install.
2. Select your Installation site with safety, as well as performance, in mind. (Detailed information on Site Selection appears in a separate section of this booklet.) **REMEMBER: ELECTRIC POWER LINES AND PHONE LINES LOOK ALIKE. FOR YOUR SAFETY, ASSUME THAT ANY OVERHEAD LINES CAN KILL YOU.**
3. Call your electric power company. Tell them your plans and ask them to come look at your proposed installation. This is a small inconvenience considering **YOUR LIFE IS AT STAKE**.
4. Plan your installation procedure carefully and completely before you begin. Successful raising of a mast or tower is largely a matter of coordination. Each person should be assigned to a specific task, and should know what to do and when to do it. One person should be designated as the "boss" of the operation to call out instructions and watch for signs of trouble.
5. When installing your antenna, **REMEMBER: DO NOT** use a metal ladder. **DO NOT** work on a wet or windy day. **DO** dress properly - shoes with rubber soles and heels, rubber gloves, long sleeve shirt or jacket.
6. If the assembly starts to drop, get away from it and let it fall. Remember, the antenna, mast, cable and metal guy wires are all excellent conductors of electrical current. Even the slightest touch of any of these parts to a power line complete an electrical path through the antenna and the installer - **THAT'S YOU!**
7. If any part of the antenna system should come in contact with a power line - **DON'T TOUCH IT OR TRY TO REMOVE IT YOURSELF. CALL YOUR LOCAL POWER COMPANY.** They will remove it safely.

If an accident should occur with the power lines call for qualified emergency help immediately.

### SITE SELECTION

Before attempting to install your antenna, think where you can best place your antenna for **safety** and **performance**.

To determine a safe distance from wires, power lines and trees:

1. Measure the height of your antenna.
2. Add this length to the length of your tower or mast, and then
3. Double this total for the minimum recommended safe distance.

If you are unable to maintain this safe distance, **STOP! GET PROFESSIONAL HELP.** Many antennas are supported by pipe masts attached to the chimney, roof or side of the house. Generally, the higher the antenna is above the ground, the better it performs. Good practice is to install your antenna about 5 to 10 feet above the roof line and away from power lines and obstructions. Remember that FCC limits your antenna height to 60 feet. If possible, find a mounting place directly above your set, where the antenna wire can take a short, vertical drop on the outside of the house for entry through a wall or window near the set. Your dealer carries a complete line of installation hardware.

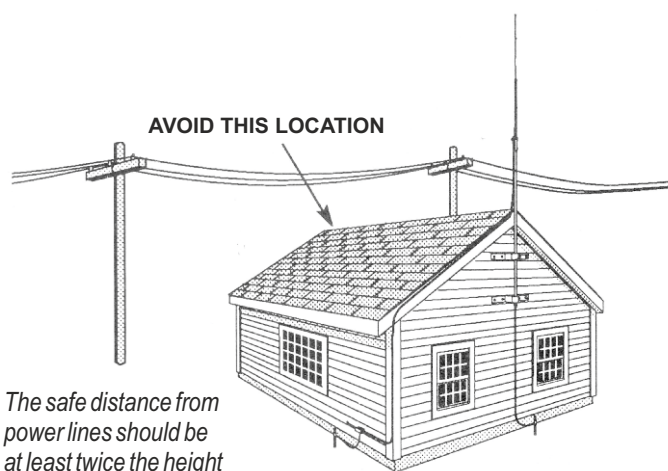

*The safe distance from power lines should be at least twice the height of the antenna and mast combined.*

### CHOOSE A PROPER SUPPORT AND MOUNTING METHOD

However you decide to mount and support your antenna always make sure that safety is your first concern. Some of the more common installation methods are illustrated below.

#### ROOF MOUNTED

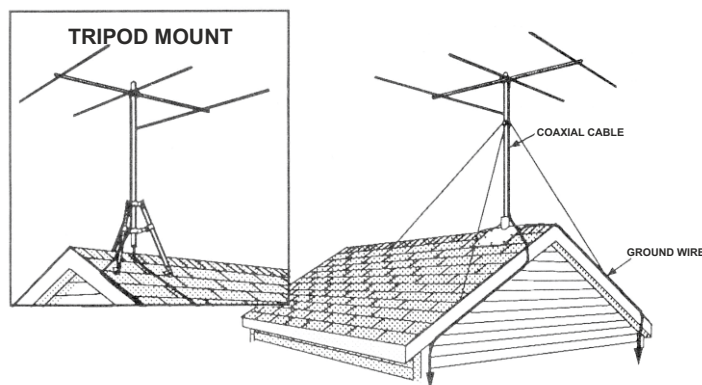

#### ROOF MOUNTING

The swivel feature of "universal" type mounting brackets makes a convenient antenna mount for flat or peaked roofs. One clamp type bracket is used with 3 or 4 guy wires equally spaced around the mast and anchored to the roof or eaves by eyebolts. Apply roofing compound around the base of the bracket, screws and eyebolts for moisture sealing.

## TELESCOPING MAST

Guy wires should be equally spaced in at least three directions. Use at least three guy wires for each 10 foot section of mast.

## SIDE OF HOUSE MOUNTING

The safe distance from power lines is at least twice the height of antenna and mast combined. Where roof overhang is not excessive, the side of the house provides a convenient mounting. Position the brackets over a stud if possible, one above the other, and space two or three feet apart. For metal siding, first mark mounting holes, then drill pilot holes through the siding to accept mounting screws.

## TOWER

Tower safety is paramount to a good installation and requires that you take location, tree growth, soil depth and proximity to buildings into consideration. Tower foundations must be securely based on a solid concrete/ tower mounting plate. An alternative is to sink a 4-6 foot section of tower into a concrete base for an extremely rugged mount. Proper guying is essential to a safe weather-resistant installation that must handle severe wind loading and is best accomplished with preformed guy grips, torque brackets and turnbuckles. When working on towers always use a safety belt made of high quality web-type material

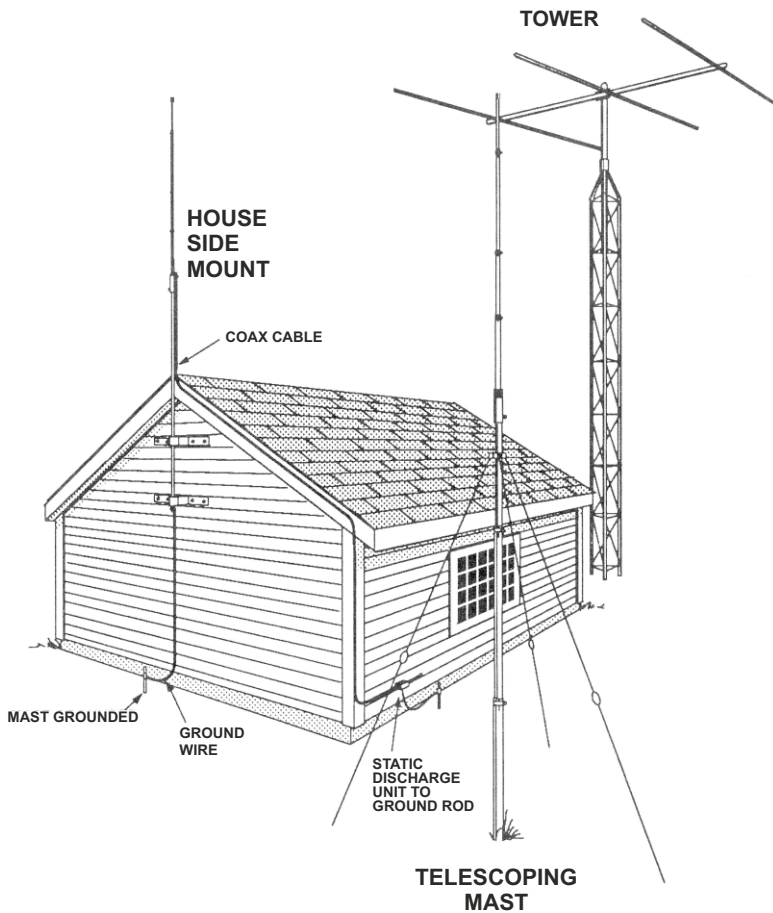

## CHIMNEY MOUNTING

The chimney is often an easy and convenient mounting place. But the chimney must be strong enough to support the antenna in high winds. Do not use a chimney that has loose bricks or mortar. A good chimney mount makes use of a 5 or 10 foot, 1-1/4" diameter steel mast, and a heavy duty two strap clamp-type bracket. Install the upper bracket just below the top course of bricks, and the lower bracket two or three feet below the upper bracket. For maximum strength, space the brackets as far apart as possible.

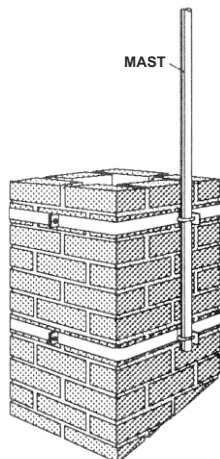

## GENERAL INSTALLATION INSTRUCTIONS FOR MAST MOUNTED ANTENNAS

1. Assemble your new antenna on the ground at the installation site. Keep separate assembly instructions that come with it. Large CB and Amateur beams may have to be finally assembled on the tower or mast.
2. On the ground, clamp the antenna to mast and connect the coax cable to the antenna.
3. To insure that the mast does not fall the "wrong way" if it should get away during the installation or takedown, durable non-conductive rope should be secured at each two foot level as the mast is raised. The boss stands in a position where he can yank or pull the ropes if the need arise to deflect the falling mast away from hazards (such as power lines) into a "safe fall" (such as a yard or driveway). The ropes are tied taut at the base of the mast after installation and in place at the various levels.
4. Install selected mounting bracket.
5. If you are going to use guy wire installation instead of a mounting bracket:
  - install guy anchor bolts
  - estimate length of guy wire and cut
  - attach a mast using guy ring
6. Carefully take antenna and mast assembly to mounting bracket and insert. Tighten camp bolts. In case of guyed installation, it will be necessary to have at least a second person hold the mast upright while the guy wires are attached and tightened to the anchor bolts.
7. Install self-adhering "DANGER" label packaged in antenna hardware kit at eye level on your mast.
8. Install ground rod to drain off static electricity build-up and connect ground wire to mast and ground rod. Use special ground rods, not a spare piece of pipe.

## EXAMPLE OF ANTENNA GROUNDING AS PER NATIONAL ELECTRICAL CODE INSTRUCTIONS

1. Use No. 10 AWG copper or No. 8 AWG or larger copper-clad steel or bronze wire, as ground wires for both mast and lead-in. Securely clamp the wire to the bottom of the mast.
2. Secure lead-in wire from antenna to antenna discharge unit and mast ground wire to house with stand-off insulators spaced from 4 feet (1.2 meters) to 6 feet (1.8 meters) apart.
3. Mount antenna discharge unit as close as possible to where the lead-in wire enters the house.
4. Drill a hole in wall (CAREFUL! There are wires in that wall.) near your set just large enough to permit entry of cable.
5. Push cable through hole and form a rain drip loop close to where it enters the house.
6. Put small amount of caulking around cable where it enters house to keep out drafts.
7. Install static electricity discharge unit.
8. Connect antenna cable to the set.

You should not attempt to raise a mast in excess of 30 feet in height/length (not including the antenna proper) in a fully-extended condition. Thirty to fifty foot tubular masts must be elevated, a section at a time, with the base or outer section secured in place with guy wires. **GET PROFESSIONAL HELP.**

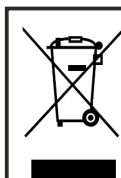
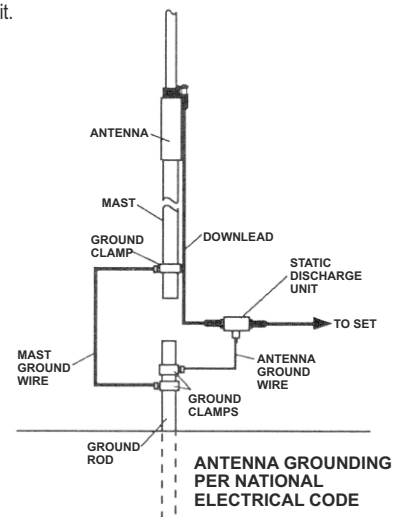

All articles displaying this symbol on the body, packaging or instruction manual of same, must not be thrown away into normal disposal bins but brought to specialised waste disposal centres. Here, the various materials will be divided by characteristics and recycled, thus making an important contribution to environmental protection.

# ATTENZIONE

**L'INSTALLAZIONE DI QUESTO PRODOTTO VICINO ALLE LINEE DELL'ALTA TENSIONE E' PERICOLOSA. SEGUIRE LE ISTRUZIONI PER LA VOSTRA SICUREZZA**

SIRIO antenne non si assume alcuna responsabilità se si utilizzano pratiche di installazione pericolose. E' disponibile personale qualificato e con esperienza per assistervi nell'installazione, manutenzione, o lo smontaggio. Contattate il vostro installatore locale per richiedere una consulenza o assistenza.

- Se state installando un'antenna per la prima volta, richiedete un'ASSISTENZA PROFESSIONALE. Consultate il vostro rivenditore che saprà spiegarvi il metodo più idoneo e sicuro per montare il tipo di antenna che volete utilizzare.
- Scegliete il luogo più sicuro per l'installazione. La distanza di sicurezza dalle linee dell'alta tensione deve essere almeno due volte l'altezza dell'antenna con il palo. **RICORDATE: LE LINEE DELL'ALTA TENSIONE E LE LINEE TELEFONICHE SONO SIMILI PERTANTO STATE LONTANO DA QUALSIASI LINEA DI TENSIONE. POTREBBE UCCIDERVI!!** Quando installate la vostra antenna, **RICORDATE:**
  - NON USATE** scale di metallo;
  - NON LAVORATE** in un giorno di vento o di pioggia;
  - UTILIZZATE** un abbigliamento appropriato (scarpe con suola in gomma, guanti in gomma, maglia con manica lunga)
- Se il vostro impianto inizia a cedere, allontanatevi e lasciatelo cadere. Ricordate che l'antenna, il palo, il cavo e i fili di metallo sono ottimi conduttori di elettricità. Anche il contatto più lieve di una di queste parti alle linee dell'alta tensione provoca un collegamento elettrico dalla linea all'installatore attraverso l'antenna.
- Se una qualsiasi parte dell'antenna dovesse entrare in contatto con una linea di elettricità, **NON TOCCATELA**. Chiamate gli operatori della società elettrica, sapranno rimuoverla in modo sicuro e corretto.

## ISTRUZIONI GENERALI

- Seguire attentamente le istruzioni di montaggio sul foglio illustrativo allegato al prodotto.
- Collegare il palo di sostegno a terra utilizzando una treccia in rame con una sezione di almeno 6 mm<sup>2</sup>.
- Assicurarsi del corretto serraggio di dadi e viti.
- Se necessario (zone molto ventose o palo di sostegno molto lungo) si consiglia l'utilizzo di tiranti di controventatura.
- NON SOSTARE** vicino all'antenna mentre sta trasmettendo.
- Si consiglia di rispettare sempre la potenza massima stabilita dalle norme vigenti
- Attaccare sul palo di sostegno l'etichetta autoadesiva "DANGER" contenuta nella confezione in posizione visibile (altezza occhi).



## INFORMAZIONE AGLI UTENTI ITALIANI INFO FOR ITALIAN USERS ONLY

ai sensi dell'art.13 del Decreto Legislativo 25 luglio 2005, n. 151 «Attuazione Direttive 2002/95/CE, 2002/96/CE e 2003/108/CE», relative alla riduzione dell'uso di sostanze pericolose nelle apparecchiature elettriche ed elettroniche, nonché allo smaltimento dei rifiuti».

Il simbolo del cassonetto barrato indica che il prodotto alla fine della propria vita utile deve essere raccolto separatamente dagli altri rifiuti. L'utente dovrà, pertanto, conferire l'apparecchiatura giunta a fine vita agli idonei centri di raccolta differenziata dei rifiuti elettrici ed elettrotecnici, oppure riconsegnare al rivenditore al momento dell'acquisto di una nuova apparecchiatura di tipo equivalente, in ragione di uno a uno. L'adeguata raccolta differenziata e l'avvio al riciclaggio, al trattamento e allo smaltimento ambientale compatibile contribuisce ad evitare effetti negativi sull'ambiente e sulla salute e favorisce il reimpiego e/o riciclo dei materiali. Lo smaltimento dei rifiuti abusivo del prodotto da parte dell'utente comporta l'applicazione delle sanzioni amministrative previste dalla normativa vigente.

# ATTENTION

**L'INSTALLATION DE CE PRODUIT PROCHE DE LIGNES A HAUTE TENSION EST DANGEREUSE. POUR VOTRE SECURITE, SUIVEZ LES INDICATIONS JOINTES.**

Sirio Antenne n'assume aucune responsabilité en cas d'installation défectueuse ou dangereuse. Il est indispensable de disposer de personnel compétent et expérimenté pour aider à l'installation, l'entretien ou le démontage du produit. Contactez votre installateur pour demander une assistance.

- Si vous installez une antenne pour la première fois, pour votre sécurité, faites-vous assister et conseiller par un PROFESSIONNEL. Consultez votre revendeur qui pourra vous expliquer la méthode de montage à utiliser en fonction de la taille et du type d'antenne que vous souhaitez monter.
- Choisissez un endroit d'installation sûr. La distance de sécurité par rapport à des lignes à haute tension, doit être du moins deux fois la hauteur de l'antenne et du mât. **RAPPEL: LES LIGNES A HAUTE TENSION ET LES LIGNES TELEPHONIQUES PEUVENT SE CONFONDRE. UNE LIGNE A HAUTE TENSION PEUT VOUS TUER!** Quand vous installez une antenne,

## RAPPELEZ-VOUS :

- N'UTILISEZ PAS** d'échelle métallique,
  - NE TRAVAILLEZ PAS** un jour humide ou venteux,
  - UTILISEZ** des vêtements appropriés (chaussure et talons en caoutchouc, gants en caoutchouc, chemise ou veste à manches longues).
- Si l'assemblage commence à tomber, s'en éloigner et le laisser tomber. Rappelez-vous que l'antenne, le mât, les câbles et les fils de fer sont d'excellents conducteurs de courant électrique. Même le plus léger contact d'une de ces pièces avec une ligne haute tension peut créer un contact électrique au travers de l'antenne et de l'installateur.
  - Si l'une des parties de l'antenne et des accessoires, venaient à être en contact avec une à ligne haute tension, **NE TOUCHEZ A RIEN, N'ESSAYEZ PAS DE DEMONTER VOUS-MÊME. APPELEZ LE FOURNISSEUR D'ELECTRICITE** qui démontera l'antenne avec les précautions requises.

## INSTRUCTIONS GENERALES pour les antennes montées sur un mât:

- Suivez avec attentions les instructions de montage du produit.
- Branchez votre mât à la masse en utilisant un fil de cuivre d'une section minimale de 6 mm<sup>2</sup>.
- Faites attention au bon serrage des écrous et des vis.
- Si nécessaire (endroits venteux ou mâts très hauts) utilisez des haubans.
- NE RESTEZ PAS** à côté de votre antenne si celle-ci est en émission (TX).
- Respectez strictement la puissance maximale exigée par la loi et la réglementation.
- Mettez un autocollant «DANGER» sur le mât, à hauteur des yeux.



Tous les articles présentant ce symbole sur le corps, l'emballage ou le manuel d'utilisation de celui-ci ne doivent pas être jetés dans des poubelles normales mais être amenés dans des centres de traitement spécialisés. Là, les différents matériaux seront séparés par caractéristiques et recyclés, permettant ainsi de contribuer à la protection de l'environnement.

# WARNUNG

**DIE INSTALLATION DIESES PRODUKTS IN DER NÄHE VON STROMLEITUNGEN IST GEFÄHRLICH. BEFOLGEN SIE ZU IHRER SICHERHEIT DIE FOLGENDEN ANWEISUNGEN.**

SIRIO Antenne übernimmt keine Haftung, wenn fehlerhafte oder gefährliche Installationspraktiken angewandt werden. Es steht geschultes und erfahrenes Personal zur Verfügung, um Sie bei der Installation, Wartung oder Demontage zu unterstützen. Kontaktieren Sie Ihren Fachhändler, wenn Beratung oder Unterstützung erforderlich ist

- Wenn Sie zum ersten Mal eine Antenne installieren, sollten Sie sich von Ihrem Fachhändler beraten lassen. Er kann Ihnen erklären, welche Montagemethode für die Größe und den Typ der Antenne, die Sie montieren wollen, zu verwenden ist.
- Wählen Sie Ihren Installationsort unter dem Gesichtspunkt der Sicherheit aus. Der Sicherheitsabstand von Stromleitungen sollte mindestens das Doppelte der gemeinsamen Länge von Antenne und Mast betragen. **OFT KÖNNEN SIE ALS LAIE ELEKTRISCHE STROMLEITUNGEN UND TELEFONLEITUNGEN NICHT UNTERSCHIEDEN. - GEHEN SIE ZU IHRER EIGENEN SICHERHEIT ZUNÄCHST EINMAL DAVON AUS, DASS JEDLICHE LUFTLEITUNGEN SIE TÖTEN KÖNNTE!!** Wenn Sie Ihre Antenne installieren, **DENKEN SIE DARAN:**
  - Verwenden sie keine Metall-Leiter.**
  - Führen sie diese Arbeiten, wenn möglich, nicht an regnerischen oder stürmischen Tagen aus.**
  - Achten sie auf richtige Kleidung:** (Schuhe mit Gummisohlen und -absätzen, Gummihandschuhe, Hemd bzw. Jacke mit langen Ärmeln).
- Sollte bei der Montage Antenne oder Mast aus irgendwelchen Gründen hinfallen, sollten Sie diese in diesem Moment nicht mehr berühren. Denken Sie daran, daß Antenne, Mast, Kabel und metallische Verankerungsdrähte ausgezeichnete Leiter von elektrischen Strom sind. Selbst die leichteste Berührung dieser Teile mit einer Stromleitung erzeugt einen elektrischen Stromkreis und kann Sie sofort töten.
- Wenn irgendein Teil des Antennensystems mit einer Stromleitung in Kontakt kommen sollte, **BERÜHREN SIE ES NICHT UND VERSUCHEN SIE NICHT, ES SELBST ZU ENTFERNEN. RUFEN SIE IHRE ÖRTLICHE ELEKTRIZITÄTSGESSELLSCHAFT AN.** Die Fachleute dieser Gesellschaften werden das Problem sicher und gefahrlos lösen.

## ALLGEMEINE MONTAGEANWEISUNGEN FÜR ANTENNEN, DIE AUF EINEM MAST MONTIERT SIND:

- Befolgen Sie sorgfältig die Montageanweisungen des Produkts.
- Verbinden Sie Ihren Mast mit einem guten Erdungspotential, indem Sie einen Kupferdraht mit einem Querschnitt von mindestens 6 mm<sup>2</sup> verwenden.
- Achten Sie auf den korrekten Sitz von Muttern und Schrauben.
- Wenn notwendig (Gegenden mit häufigen starken Winden bzw. Stürmen oder sehr hohe Masten) wird die Verwendung von speziellen Abspannseilen (Erhältlich im guten Fachhandel) empfohlen.
- Halten Sie sich nicht** in der Nähe Ihrer Antenne auf, während Ihr Funkgerät im



Sendemodusist.

- Es wird empfohlen, die gesetzlich festgelegte maximale Leistung des Funkgerätes nicht zu überschreiten.
- Kleben Sie das der Antenne beiliegende selbstklebende Etikett "DANGER" in Augenhöhe an Ihren Mast.



Alle Artikel, die auf der Verpackung oder der Gebrauchsanweisung dieses Symbol tragen, dürfen nicht in den normalen Mülltonnen entsorgt werden, sondern müssen an gesonderten Sammelstellen abgegeben werden. Dort werden die Materialien entsprechend ihrer Eigenschaften getrennt und, um einen Beitrag zum Umweltschutz zu liefern, wiederverwertet.

## ES HOJA DE INFORMACIÓN DE SEGURIDAD

### ATENCIÓN

**LA INSTALACIÓN DE ESTE PRODUCTO CERCA A UNA LÍNEA DE ALTA TENSION PUEDE SER PELIGROSO. SIGA ATENTAMENTE LAS INSTRUCCIONES PARA SU SEGURIDAD.**

SIRIO Antenne no asume ninguna responsabilidad si se efectúan acciones irresponsables o peligrosas en el momento de la instalación. Hay personal disponible, capacitado y con la experiencia necesaria para ayudar o realizar el mantenimiento, montaje y desmontaje. Póngase en contacto con su instalador local si precisa asesoramiento o asistencia.

- Si usted pretende instalar una antena por primera vez, déjese aconsejar por un profesional, consulte en su establecimiento habitual y siga todas sus recomendaciones.
- Elija el lugar más seguro para la instalación. La distancia de seguridad con respecto a la línea de alta tensión, deberá ser al menos dos veces la altura de la antena, una vez instalada en el mástil. **RECUERDE: LAS LÍNEAS DE ALTA TENSION Y LAS LÍNEAS TELEFÓNICAS SON PARECIDAS. PARA SU SEGURIDAD MANTENGASE ALEJADO DE ELLAS.** Cuando instale la antena, **RECUERDE:**
  - NUNCA utilice una escalera metálica**
  - NO pretenda instalar la antena** en un día con viento, lluvia o nieve.
  - UTILICE** ropa y material adecuado (zapatos aislantes con suela de goma, guantes de goma, camisa de manga larga)
- Si la instalación no está bien efectuada, ésta podría caer, ocasionar grandes desperfectos e incluso causando daños a terceros. Le recomendamos proceda con extrema precaución.
- Si una parte de la antena entrara en contacto con algún cable eléctrico **ALEJESE INMEDIATAMENTE.** Llame urgentemente a la compañía eléctrica, **NO intente resolver por su cuenta el incidente.** Ellos sabrán solucionar el problema de un modo correcto y seguro.

#### INSTRUCCIONES GENERALES

- Siga atentamente las instrucciones de la hoja ilustrativa que acompaña al producto.
- Si tiene alguna duda **NO prosiga con la instalación.** Consulte personal cualificado
- Derive a tierra el mástil de sujeción mediante un cable de 6mm<sup>2</sup> de sección mínimo.
- Verifique que los tornillos y tuercas han sido debidamente fijados.
- Si es necesario (zonas de mucho viento o mástiles muy largos) utilice tirantes de viento.
- NO PERMANEZCA** cerca de la antena mientras se está transmitiendo.
- Se aconseja siempre respetar la potencia máxima establecida por las normas vigentes
- Coloque en el mástil la etiqueta autoadhesiva "DANGER" suministrada con la antena, situela en un lugar lo suficientemente visible. (Altura de la vista)



Todos los artículos que exhiban este símbolo en el cuerpo del producto, en el embalaje o en el manual de instrucciones del mismo, no deben ser desechados junto a los residuos urbanos normales sino que deben ser depositados en los centros de recogida especializados. En estos centros, los materiales se dividirán en base a sus características y serán reciclados, para así poder contribuir de manera importante a la protección y conservación del medio ambiente.

## RU информация о безопасности

### ВНИМАНИЕ

**установка данного устройства возле высоковольтных линий электропередачи опасна для жизни! Следуйте прилагаемой инструкции!**

SIRIO Antenne не несет никакой ответственности за неисправности, произошедшие в результате неправильного монтажа. Привлекайте обученный и опытный персонал для оказания помощи в установке, техническом обслуживании, сборке или разборке. Свяжитесь с вашим местным установщиком для консультации или помощи, в случае необходимости.

- Если Вы устанавливаете антенну в первый раз, найдите профессионального помощника. Ваш дилер может объяснить Вам способ установки антенны в зависимости от типа и размера антенны.
- Тщательно выбирайте место установки. Расстояние до высоковольтной ЛЭП должно, как минимум, дважды превышать высоту мачты и антенны.

**ПОМНИТЕ: высоковольтные ЛЭП, а также телефонные и другие кабельные линии находятся под напряжением, которое опасно для жизни!**

Во время установки антенны **ПОМНИТЕ:**

- не используйте металлическую лестницу;
- не работайте во влажную и ветряную погоду;
- наденьте рубашку или куртку с длинными рукавами, обувь на резиновой подошве, а также используйте резиновые перчатки.

- Если собираемая часть начинает падать немедленно отойдите в сторону и не препятствуйте падению. Помните, что антенна, мачта, кабель и металлические провода являются проводниками электрического тока. Даже легкое касание любой из составных частей антенной системы к открытому источнику электроэнергии может привести к короткому замыканию или поражению электрическим током.
- Если одна из частей устанавливаемой антенной системы в результате падения или по другой причине соприкоснулась с источником электроэнергии, **НЕ ПЫТАЙТЕСЬ САМОСТОЯТЕЛЬНО УСТРАНИТЬ ЭТО, ПОЗВОНИТЕ В АВАРИЙНУЮ СЛУЖБУ!**

#### ОСНОВНЫЕ ИНСТРУКЦИИ ПО УСТАНОВКЕ АНТЕННЫ НА МАЧТУ

- Внимательно следуйте инструкции по установке антенны.
- Заземлите мачту медным проводом с сечением не менее 6 кв. мм.
- Установите антенну, обращая внимание на правильность сборки и надежность затяжки болтов и гаек.
- Если необходимо (районы с повышенными ветряными нагрузками или слишком длинная мачта) используйте специальные противоветровые направляющие.
- Не находите вблизи антенны во время передачи.
- Рекомендуется использовать максимально разрешенную мощность передачи в соответствии с законодательством.
- Наклейте этикетку "DANGER" упакованную вместе с антенной на мачту, на

## PL KARTA INFORMACJI BEZPIECZEŃSTWA

### UWAGA

**INSTALOWANIE ANTEN W POBLIŻU LINII WYSOKIEGO NAPIĘCIA JEST NIEBEZPIECZNE!**

SIRIO Antenne nie ponosi żadnej odpowiedzialności w razie awarii instalacji w wyniku błędnego zamontowania lub stosowanych niebezpiecznych praktyk. W przypadku problemów podczas montażu należy skontaktować się z przeszkolonym i doświadczonym personelem jak i w celu konserwacji czy demontażu.

- Montując antenę po raz pierwszy, dla własnego bezpieczeństwa, poproś o pomoc specjalistów.
- Wybierz starannie miejsce montażu w odległości minimum 2 długości anteny plus masztu od linii energetycznej. Nie używaj metalowej drabiny, załóż buty z gumową podeszwą, rękawiczki, koszulę z długim rękawem i nie pracuj w złych warunkach pogodowych.
- Jeżeli montowana konstrukcja zaczyna się przewracać nie podtrzymuj jej.
- Jeżeli część instalacji już dotknęła kabli z prądem nie usuwaj jej sam tylko zadzwoń od zakładu energetycznego.

#### Podstawowe instrukcje:

- Zapoznaj się z instrukcją produktu.
- Uziemij maszt przewodem min. 6 mm<sup>2</sup>.
- Starannie skręcaj połączenia.
- Używaj odpornych na wiatr elementów masztu.
- Nie przebywaj w pobliżu anteny podczas nadawania.
- Nie przekraczaj limitów mocy.
- Oznacz instalacje ostrzegawczą nalepką «DANGER».

## CZ BEZPEČNOSTNÍ INFORMACNÍ LIST.

### VAROVANI

**NEMANIPULUJTE S ANTENOU POBLIŽ ELEKTRICKEHO VEDENÍ!**

SIRIO nepřebírá žádnou zodpovědnost v případě neodborné či nebezpečné montáže. Montáž, údržbu nebo demontáž svěřte kvalifikovanému odbornému servisu.

- Pokud nemate s montazi zkušenosti, použijte odbornou firmu
- Používejte ochranný oblek
- Pri istalaci do anteny nevysilejte
- Pri jakemkoli kontaktu s elektrickým vedením informujte rozvodne zavody

#### Zakladni instrukce:

- Pozorne ctete montazni navod
- Antenni stozar uzemnete vodícem 6mm<sup>2</sup>
- Zvysenou pozornost venujte kontaktum a spojum
- Nemontujte antenu v extreme nepriznivem pocasi
- Pri vysilani se nedotykejte zarice
- Nepouzivejte vysi vykon nez je vyrobcom urceno
- Antenu oznacte stítkem "DANGER"

# BLIZZARD 2700

## 26...28 MHz Tunable Base Station Antenna

### DESCRIPTION

The most modern technology and the most advanced instruments have been used for the realization of BLIZZARD 2700, the new base antenna with remarkable characteristics. It is made of Silicon Magnesium Aluminium tubes of big dimensions drawn and cemented on the surface to get the maximum strenght of the main whip. The coil, made of enamelled copper wire of big section, has been specially planned in order to bear high powers. It adopts the exclusive system C.A.C.S. (Coil Auto-Cooling System) which allows the auto-cooling by a finned support that keeps the coil hanging up allowing the air circulation.

### SPECIFICATIONS

#### Electrical Data

Type	: 5/8 $\lambda$ Ground Plane
Frequency range	: 26...28 MHz tunable (see table)
Impedance	: 50 $\Omega$
Radiation (H-plane)	: 360° omnidirectional
Polarization	: Linear Vertical
Gain	: 1.5 dBd, 3.65 dBi
Bandwidth @ SWR $\leq 2$	: $\geq 2000$ KHz (180 channel)
SWR @ res. freq.	: $\leq 1.1$
Max Power	: 1000 Watts (CW) continuous : 3000 Watts (CW) short time
Feed system/ position	: Transformer DC-ground / base
Connector	: UHF-female

#### Mechanical Data

Materials	: Aluminium, Steel, Copper, Nylon
Wind Load/ Resistance	: 264 N @ 150Km/h / 130 Km/h
Wind surface	: 0.23 m <sup>2</sup>
Length (approx.)	: 6700 mm
Weigth (approx.)	: 6000 gr
Radial lenght	: 1400 mm
Mounting Mast	: $\varnothing$ 35-39 mm

TYPICAL S.W.R. RESPONSE

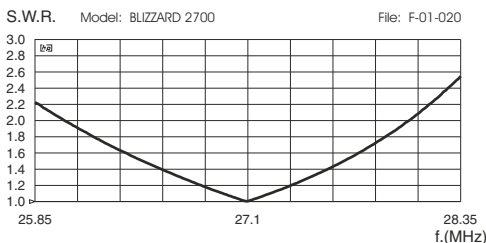

## WARNING

**INSTALLATION OF THIS PRODUCT NEAR POWER LINES IS DANGEROUS. FOR YOUR SAFETY AND BEFORE YOU BEGIN INSTALLATION, READ THE SEPARATE SAFETY INFORMATION SHEET.**

### ADDITIONAL ANTI NOISE NYLON RING



Additional nylon ring to reduce the wind noise of the radials.  
P/N: 2511011.00

### ADDITIONAL FT2 FIXING BRACKET

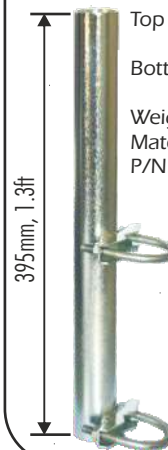

Top size:  $\varnothing$  38mm-1.5in for antenna fitting  
Bottom Size:  $\varnothing$ 42/50mm-1.6/1.9in for fitting on the mast  
Weight (approx.): 1100 gr, 2.4 lb  
Material: Galvanized steel  
P/N: 2510004.00

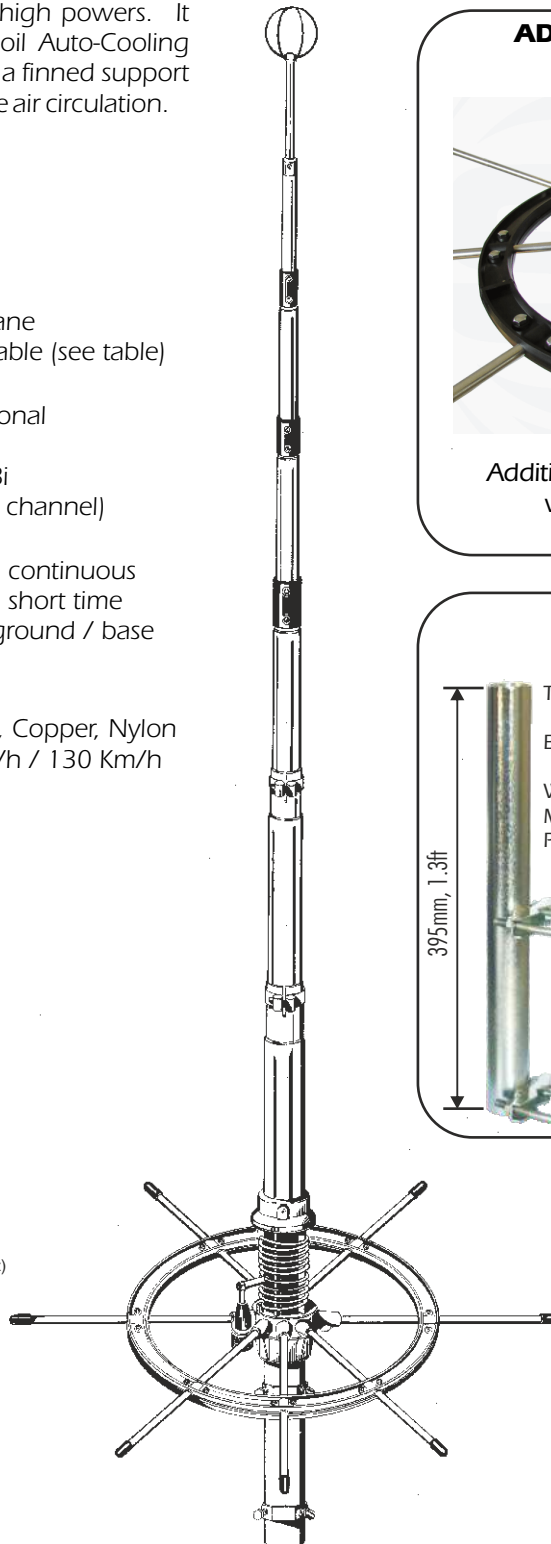
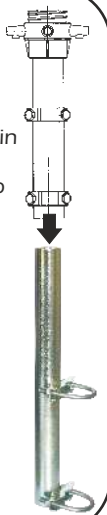

TUNING TABLE	
Freq. (MHz)	L (mm)
26.0	670
26.5	474
27.0	300
(Ch.19 CB) 27.185	250
27.5	151
28.0	10

Mounting needed tools:	
n. 1	tape rules (meter)
n. 1	phillips screwdriver
n. 1	10 mm open key
n. 1	13 mm open key

Parts List		
Pos	Q.ty	Description
1	1	4 sections telescopic aluminium whip
2	3	plastic jointing sleeves (4 different sizes)
3	6	∅ 3.9x6.5 phillips tapping screws
4	1	top section with cage
5	1	M4x4 hexagon socket set screw cup point
6	1	2mm hexagonal key
7	1	∅ 33.5x37x1100 mm aluminium tube
8	1	∅ 32-35 mm hose clamp
9	1	Bottom section assembled with coil and connetor
10	1	∅ 40-43 mm hose clamp
11	9	PVC caps for ∅ 8 mm aluminium tube
12	8	∅ 6x8x1400mm aluminium tubes
13	8	brass radials reinforces
14	8	M6x6 hexagon socket set screws cup point
15	1	3mm hexagonal key
16	2	AISI 302 stainless steel rings
17	4	M8x30 exagon head screws
18	4	M8 square nuts

### MOUNTING INSTRUCTIONS

**1**

Pull out the sections of telescopic aluminium whip (1), insert the plastic jointing sleeves (2) and lock they using the screws (3). Insert the top part with cage (4) at L (see tuning table for frequency) and lock it using the screw (5) and 2mm hexagonal key (6).

**NOTE:** Use the table just as a guide. For fine-tuning please use an SWR-meter

**2**

Fit the whip (1) on the tube (7) using the hose clamp (8). Mount the tube (7) on the bottom part with coil (9) and lock it using the hose clamp (10).

**3**

Insert the PVC cap (11) on the radials (12). Insert the brass reinforce (13) in the tubes (12) and lock they using the screws (14) and 3mm hexagonal key (15). Assemble the fixing ring (16), the screws (17) and the nuts (18) in according to the picture and mount the antenna on the mast.