

Bugera

THE SOUL OF VALVES

**333XL/333XL-212/333/333-212
User Manual**

Important safety instructions



CAUTION: High voltage! Risk of death! High voltages of up to 500 V DC may be present inside the casing for long periods after being disconnected from the mains. To avoid lethal electric shock, do not open the casing. There are no user-serviceable components inside. Refer all maintenance to qualified service personnel. Remove the mains cable when the unit is not in use.

WARNING: To eliminate the risk of fire and electric shock, do not expose this unit to rain or moisture and splashing or dripping liquid, which might enter the device. Do not place any objects filled with liquid, such as vases, on the unit.



This symbol, wherever it appears, alerts you to the presence of uninsulated dangerous voltage inside the enclosure—voltage that may be sufficient to constitute a risk of shock.



This symbol, wherever it appears, alerts you to important operating and maintenance instructions in the accompanying literature. Please read the manual.

- 1) Read these instructions.
- 2) Keep these instructions.
- 3) Heed all warnings.
- 4) Follow all instructions.
- 5) Do not use this apparatus near water.
- 6) Clean only with dry cloth.
- 7) Do not block any ventilation openings. Install in accordance with the manufacturer's instructions.
- 8) Do not install near any heat sources such as radiators, heat registers, stoves, or other apparatus (including amplifiers) that produce heat.
- 9) Do not defeat the safety purpose of the polarized or grounding-type plug. A polarized plug has two blades with one wider than the other. A grounding type plug has two blades and a third grounding prong. The wide blade or the third prong are provided for your safety. If the provided plug does not fit into your outlet, consult an electrician for replacement of the obsolete outlet.
- 10) Protect the power cord from being walked on or pinched particularly at plugs, convenience receptacles, and the point where they exit from the apparatus.
- 11) The apparatus shall be connected to a MAINS socket outlet with a protective earthing connection.
- 12) Where the MAINS plug or an appliance coupler is used as the disconnect device, the disconnect device shall remain readily operable.
- 13) Only use attachments/accessories specified by the manufacturer.
- 14) Use only with the cart, stand, tripod, bracket, or table specified by the manufacturer, or sold with the apparatus. When a cart is used, use caution when moving the cart/apparatus combination to avoid injury from tip-over.



- 15) Unplug this apparatus during lightning storms or when unused for long periods of time.
- 16) Refer all servicing to qualified service personnel. Servicing is required when the apparatus has been damaged in any way, such as power supply cord or plug is damaged, liquid has been spilled or objects have fallen into the apparatus, the apparatus has been exposed to rain or moisture, does not operate normally, or has been dropped.
- 17) **CAUTION!** - These service instructions are for use by qualified service personnel only. To reduce the risk of electric shock do not perform any servicing other than that contained in the operation instructions unless you are qualified to do so.
- 18) **CAUTION!** During use, the valves get very hot and high surface temperatures may be reached at the rear of this unit. To avoid burning yourself, make all connections while the unit is still cold.

Table of contents

IMPORTANT NOTICE!	4
Introduction	4
Before you get started	4
Online registration	4
Control elements	5
Front panel.....	5
Rear panel.....	6
Footswitch	7
Inside the BUGERA	7
Instructions for qualified service personnel only	7
Wiring the BUGERA	8
Audio connections	9
Specifications	10
Limited warranty	11

IMPORTANT NOTICE!

FAILURE TO OBSERVE THE FOLLOWING POINTS MAY RESULT IN DAMAGE TO THE AMPLIFIER OR LOUDSPEAKERS. DAMAGES CAUSED IN SUCH A WAY ARE NOT COVERED BY WARRANTY.

- **Before you start, always make sure that your Bugera Valve Amplifier is connected to a suitable loudspeaker. Observe the correct impedance for your loudspeaker and use the appropriate output socket.**
- **Always use loudspeaker cables for connection between the amplifier and the loudspeaker. Never use other types of cable, like instrument cable or microphone cable.**

Switching the amplifier on and off:

- **Before connecting the amplifier to a power outlet, make sure that both POWER and STANDBY switches are set to the OFF position.**

Power on (mandatory):

- **Switch the POWER switch on—wait for 60 seconds—then switch the STANDBY switch on.**

Power off (recommended):

- **Switch the STANDBY switch off—wait for 30 seconds—then switch the POWER switch off.**

Note—after powering off we recommend that the amplifier is allowed to cool down for ten minutes before any attempt is made to move the amplifier. This reduces the risk of mechanical damage to the sensitive valve elements.



ATTENTION! TO AVOID DAMAGE TO YOUR AMP, NEVER USE THE BUGERA VALVE AMPLIFIER WITHOUT A LOUDSPEAKER CONNECTED!

Introduction

Congratulations! By purchasing the BUGERA, you have chosen a state-of-the-art valve amplifier.

This 120-Watt full-valve amp offers you 3 full-fledged channels with 3 tone controls, a separate switchable Effects Loop plus integrated Reverb and much more. This way you're in full control and can get down to the nitty-gritty—your music! Discover the sound of the BUGERA and be inspired by its versatility. Whatever style you play, this monster amp gives you the full valve power that you require.

Before you get started

Your product was carefully packed at the factory to ensure safe transport. Nevertheless, if the box is damaged inspect the unit immediately for signs of damage.

- **If the unit is damaged please do NOT return it to us, but notify your dealer and the shipping company immediately; otherwise, claims for damage or replacement may not be granted.**
- **Always use the original box to prevent damage during storage or transport.**

- **Make sure that children cannot play unsupervised with the unit or its packaging.**
- **Please ensure proper disposal of all packing materials.**

Ensure adequate air supply and to avoid overheating do not place the unit near radiators etc.

- **Please make sure that all devices are properly grounded. For your own safety, never remove or disable the ground conductors from the devices or on the power cords. The unit must always be connected to the mains outlet with a protective grounding connection.**
- **The tone quality may diminish within the range of powerful radio broadcasting stations and high-frequency sources. Increase the distance between the transmitter and the unit, and use shielded cables for all connections.**

Online registration

Please do remember to register your new BUGERA equipment right after your purchase by visiting www.bugera-amps.com and kindly read the terms and conditions of our warranty carefully.

Should your BUGERA product malfunction, our goal is to have it repaired as quickly as possible. To arrange for warranty service, please contact the retailer from whom the equipment was purchased. Should your BUGERA dealer not be located in your vicinity, you may directly contact the BEHRINGER company nearest to you. This contact information is included in the original equipment packaging (Global Contact Information/European Contact Information). Should your country not be listed, please contact our exclusive distributor BEHRINGER Singapore (BEHRINGER Holdings (Pte) Ltd., 1 Kim Seng Promenade #08-08, Great World City West Tower, Singapore 237994, Tel.: +65 6845 1800, Fax: +65 6214 0275).

Registering your purchase and equipment with us helps us process your repair claims quicker and more efficiently.

Thank you for your cooperation!

CAUTION!

- **Please note that high volume levels may cause permanent damage to your hearing and/or your loudspeakers. Turn the MASTER control to the left before switching on the unit. Be sure to keep the volume at an appropriate level.**

Control elements

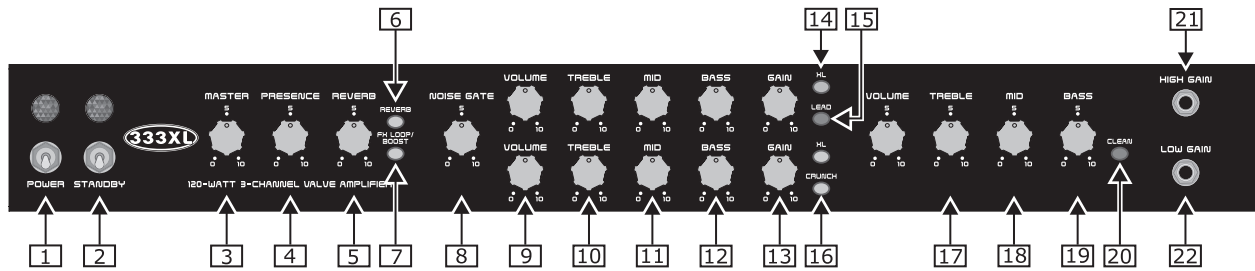

Front panel of the BUGERA 333XL

Front panel

- 1 The **POWER** switch is used to turn the power of the BUGERA amplifier on and off.
- 2 The **STANDBY** switch allows you to place the amp in STANDBY mode. This way the amp is idle, but the operational temperature of the valves is maintained (POWER switch turned on). Flick the STANDBY switch to change to the active mode (the above status light illuminates).



ATTENTION! TO AVOID DAMAGE TO YOUR AMP, NEVER USE THE BUGERA VALVE AMPLIFIER WITHOUT A LOUDSPEAKER CONNECTED!

- 3 The **MASTER** control adjusts the volume level of the BUGERA. First, bring the levels of the amplifier's three channels into line and only then specify the overall level with the MASTER control. Turn the control to the right to increase the volume; turn it to the left to reduce the volume.
- 4 The **PRESENCE** control modifies the amp's damping factor at high frequencies (only 333XL and 333XL-212). This is used to fine-tune the high-frequency range of the speaker cabinet.
- 5 The **REVERB** control determines the amount of the built-in reverb effect.
- 6 The **REVERB** switch activates the REVERB effect (switch glows yellow).
- 7 The **FX LOOP/BOOST** switch activates the FX LOOP and the BOOST function (switch glows green).
 - You can also activate the FX LOOP with the supplied footswitch. Refer to „Footswitch“ for details.
- 8 The **NOISE GATE** control determines the effect the NOISE GATE filter has on the LEAD and CRUNCH channels (only 333XL and 333XL-212). The further you turn the control to the right, the more noise is reduced. At low GAIN settings, the NOISE GATE shouldn't be set too high or else the tones' sustain is affected.
- 9 The **VOLUME** controls adjust the volume levels of all three amplifier channels.
- 10 The **TREBLE** controls of the LEAD and CRUNCH channels adjust the upper frequency range (active shelving control for up to 15 dB boost/cut).
- 11 The **MID** controls of the LEAD and CRUNCH channels adjust the mid-frequency range (active peak/notch control for up to 15 dB boost/cut).
- 12 The **BASS** controls of the LEAD and CRUNCH channels adjust the lower frequency range (active shelving control for up to 15 dB boost/cut).
- 13 The **GAIN** control lets you determine the input level of the LEAD and CRUNCH channels (the CLEAN channel doesn't feature a GAIN control). Turn the control to the right to increase the preamplifier's distortion and sustain.
 - Please note that extremely high GAIN and VOLUME settings in conjunction with high MASTER settings can make the combo models vibrate mechanically. This may occur when played at extremely high volume levels, which is seldom done. Should this be the case, adjust the GAIN and VOLUME settings so that the problem does not recur.
- 14 The **XL** switches of the LEAD and CRUNCH channels change the amplifier's response at low frequencies (only 333XL and 333XL-212). It fattens up the tone by providing more low-end.
- 15 The **LEAD** switch activates the LEAD channel (switch glows red).
- 16 The **CRUNCH** switch activates the CRUNCH channel (switch glows yellow).
- 17 The passive **TREBLE** control adjusts the upper frequency range of the CLEAN channel.
- 18 The passive **MID** control adjusts the mid frequency range of the CLEAN channel.
- 19 The passive **BASS** control adjusts the lower frequency range of the CLEAN channel.
- 20 The **CLEAN** switch activates the CLEAN channel (switch glows red).
 - You can activate the three channels with the supplied footswitch. Refer to „Footswitch“ for details.
- 21 The **HIGH GAIN** input (333 and 333-212: INPUT) is 6 dB louder than the LOW GAIN input and is used for most electric guitars.
- 22 The **LOW GAIN** input is used for instruments with an extremely high output level which could distort the HIGH GAIN input (only 333XL and 333XL-212).
 - The HIGH GAIN and LOW GAIN connectors have identical sensitivity when used at the same time (both with LOW GAIN sensitivity).

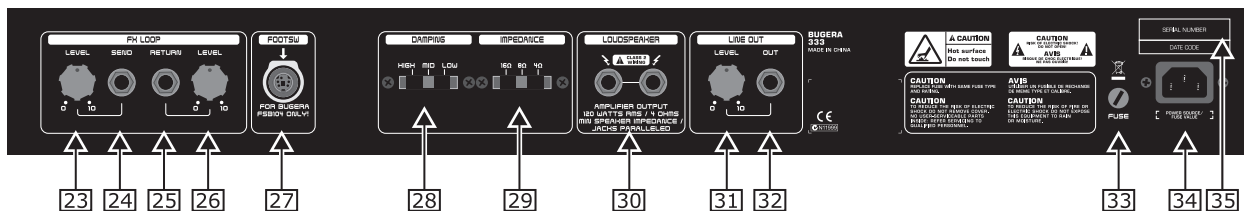

Rear panel of the BUGERA 333

Rear panel



CAUTION!

Hot! Risk of injury! During use, the valves get very hot and high surface temperatures may be reached at the rear of this unit. Avoid touching the controls and connectors on the rear panel during use. To avoid accidental contact with hot surfaces, place the rear panel so that it faces a wall.

- 23 The calibrated **LEVEL** control determines the signal level sent to an external effects unit or any other signal processor (0 – 10). Turn the control to the right to increase the amount of signal information, and turn it to the left to decrease the amount. It makes sense to select a high setting in order to get a possibly noise-free signal. The FX Send Level and FX Return Level (26) controls should always be set oppositely. For example, to reach a 0 dB working level when the FX Send Level is set low, the FX Return Level (26) needs to be set high accordingly. On the other hand, if you wish to boost the volume level, turn both controls to a higher setting.
- 24 The **SEND** output is used to connect a shielded ¼" mono jack cable to the input of an external effects unit.
- 25 The **RETURN** input is used to connect a shielded ¼" mono jack cable to the output of an external effects unit.
- 26 The calibrated **LEVEL** control determines the signal level returned from an external effects unit or any other signal processor (0 – 10). Turn the control to the right to increase the amount of signal information, and turn it to the left to decrease the amount. To achieve a possibly noise-free signal, set the FX Send Level (23) relatively high and the FX Return Level relatively low. A BOOST effect can be achieved with this LEVEL control when the RETURN input isn't being used. Increase the volume level with this control plus activate the FX LOOP with the footswitch in order to make the guitar signal louder. This function is great for highlighting solos.
- 27 The 7-pin **FOOTSW**(itch) connector is provided to connect to the supplied BUGERA FSB104 footswitch. Please be sure to connect the cables before switching on the amplifier. Refer to „Footswitch“ for details.
- 28 The **DAMPING** switch lets you specify the damping factor of the BUGERA (only 333 and 333-212). The term „damping“ refers to a feature of the amplifier that affects the signal's fade-out phase. A high damping factor (HIGH) makes the signal fade out quicker than a low factor (LOW). Changes to the damping factor automatically result in level alterations which should be re-adjusted.

- 29 The **IMPEDANCE** switch lets you specify the loudspeaker impedance. Always apply the value that is identical to the impedance of the used speaker cabinet. When connecting two cabinets with the same impedance, the switch should be set to half the value of one of the cabinets. For example, two 16-Ohm cabinets would require an 8-Ohm setting, while two 8-Ohm cabinets need to be set to the minimum impedance of 4 Ohms. Please also read „Wiring the BUGERA“.



- 30 Both the paralleled **LOUDSPEAKER** outputs (¼" mono jacks) are used to connect the speaker cabinet(s). The minimum impedance is 4 Ohms. The IMPEDANCE switch should always be set to match the impedance of the used speaker cabinet.



ATTENTION! TO AVOID DAMAGE TO YOUR AMP, NEVER USE THE BUGERA VALVE AMPLIFIER WITHOUT A LOUDSPEAKER CONNECTED!

- 31 This is the **LEVEL** control that specifies the signal level for the OUT (32) in order to adjust the level of a second amplifier and loudspeaker system connected over the OUT to the LOUDSPEAKER outputs (30) of one or more connected speaker cabinets.
- 32 The **OUT** provides a preamp signal in order to feed the signal to a second amplifier and loudspeaker system, for example.



- 33 **WARNING: ONLY REPLACE THE FUSE WHEN THE MAINS CABLE HAS BEEN DISCONNECTED!** The **FUSE** is found in the fuse holder. If the fuse is blown, it needs to be replaced with a fuse of the same kind by all means. Otherwise, the unit could seriously be damaged, in which case the warranty is void. If the fuse is blown repeatedly, you should take the unit to a qualified service technician.



- 34 The **IEC MAINS** connector is used to connect the mains cable that has the appropriate voltage ratings for your country (included). At all times, make the connections to the amplifier before plugging the cable into a power outlet.

- 35 This is the **SERIAL NUMBER** of the amplifier.

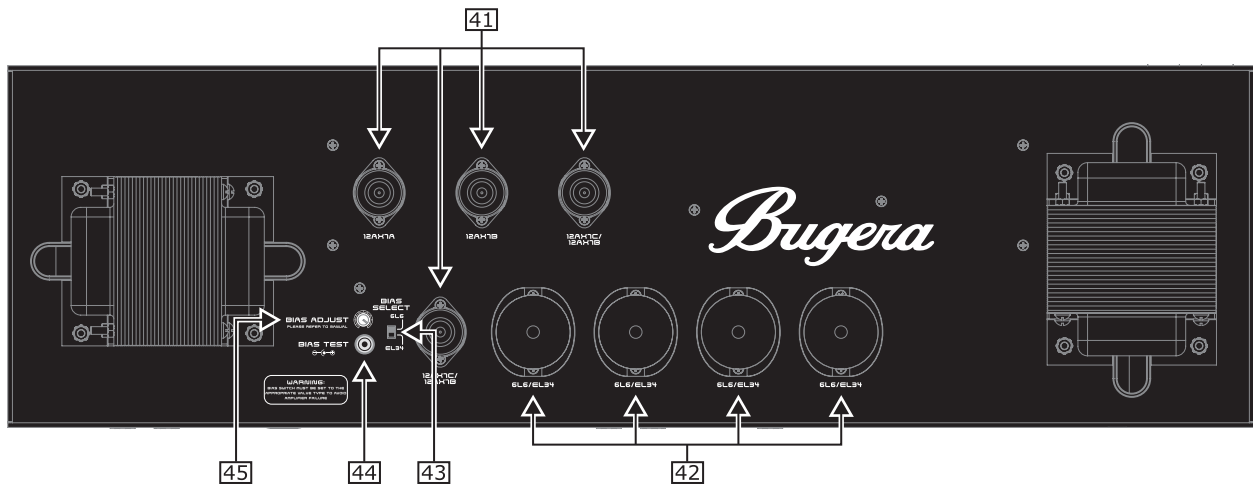

Inside the BUGERA 333

Footswitch

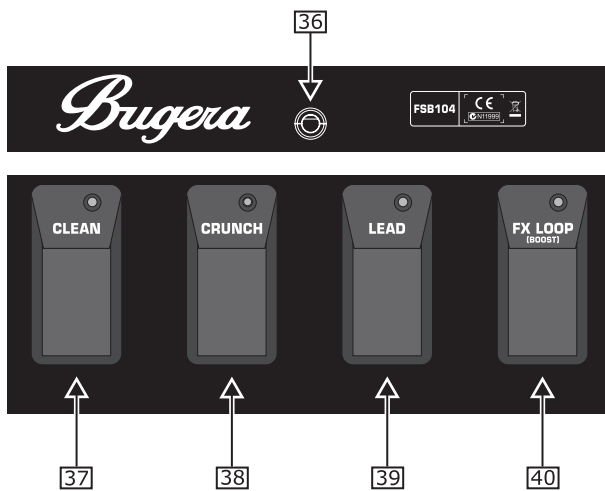

Footswitch BUGERA FSB104

- 36 The 7-pin **DIN** connector is provided to connect the footswitch cable (included). Then, the cable is connected to the FOOTSW(itch) connector of the BUGERA amplifier. Be sure to make a connection before switching on the amplifier.
- 37 The **CLEAN** switch activates the CLEAN channel. Its LED illuminates when the channel is active.
- 38 The **CRUNCH** switch activates the CRUNCH channel. Its LED illuminates when the channel is active.
- 39 The **LEAD** switch activates the LEAD channel. Its LED illuminates when the channel is active.
- 40 The **FX LOOP** switch activates the FX LOOP and the BOOST function. Its LED illuminates when the FX LOOP is active.

Inside the BUGERA



DANGER!

High voltage! Risk of death!

High voltages of up to 500 V DC may be present inside the casing for long periods after being disconnected from the mains. To avoid lethal electric shock, do not open the casing. There are no user-serviceable components inside. Refer all maintenance to qualified service personnel. Remove the mains cable when the unit is not in use.



The parts inside the amplifier operate at high voltages and high temperatures. To avoid damage and injury that results from fire or electric shock, do not drop or spill anything into the unit's casing.

Instructions for qualified service personnel only

Remove the backside of the amplifier's casing to get to the valves and the control elements.

- 41 These are the sockets for the **12AX7A/B/C** pre-amp valves.
- 42 These are the sockets for the **6L6** and **EL34** power amp valves. Please take care that the BIAS SELECT-switch (43) is set correctly. The models 333 and 333-212 are supplied with 6L6GC power amp valves when it leaves the factory. The models 333XL and 333XL-212 incorporate EL34 power amp valves.
- 43 The **BIAS SELECT** switch allows the amplifier to optimally adapt to the used valves (6L6 or EL34).



- 44 The **BIAS TEST** connector lets you connect a voltmeter in order to measure the power amp valves (bias adjustment). Make sure that the voltmeter is set to direct current (DC).
 - 45 The **BIAS ADJUST** control is used to make the bias-adjustment.
- **Replacing the power amp valves also requires bias adjustment. You should always use sets of four matched valves. The valves of the BUGERA Series are ideal for this purpose.**



CAUTION: WE HIGHLY RECOMMEND THAT BIAS ADJUSTMENTS BE CARRIED OUT BY QUALIFIED PERSONNEL!

Wiring the BUGERA



CAUTION!

Hot! Risk of injury! During use, the valves will get very hot and high surface temperatures may be reached at the rear of this unit. To avoid burning yourself, make all connections while the unit is still cold.



ATTENTION! TO AVOID DAMAGE TO YOUR AMP, NEVER USE THE BUGERA VALVE AMPLIFIER WITHOUT A LOUDSPEAKER CONNECTED!

The BUGERA amplifier has two paralleled LOUDSPEAKER outputs which are used to connect one or two speaker cabinets.

If you only connect one speaker cabinet, be sure that the IMPEDANCE switch is set to match the impedance of the connected cabinet.

If you want to connect two speaker cabinets, both cabinets should have to the same impedance. Be sure to have set the IMPEDANCE switch correctly. In this case, set it to half the value of one of the cabinets. When using two

16-Ohm cabinets, the switch therefore needs to be set to 8 Ohms; and with two 8-Ohm cabinets, set it to the minimum impedance of 4 Ohms.

CAUTION: The loudspeakers in the combos are connected in series. This results in an impedance of 16 Ohms.

Speaker cabinets	IMPEDANCE switch		
	16 Ω	8 Ω	4 Ω
1 x 16 Ω	✓		
1 x 8 Ω		✓	
1 x 4 Ω			✓
2 x 16 Ω		✓	
2 x 8 Ω			✓

Impedances

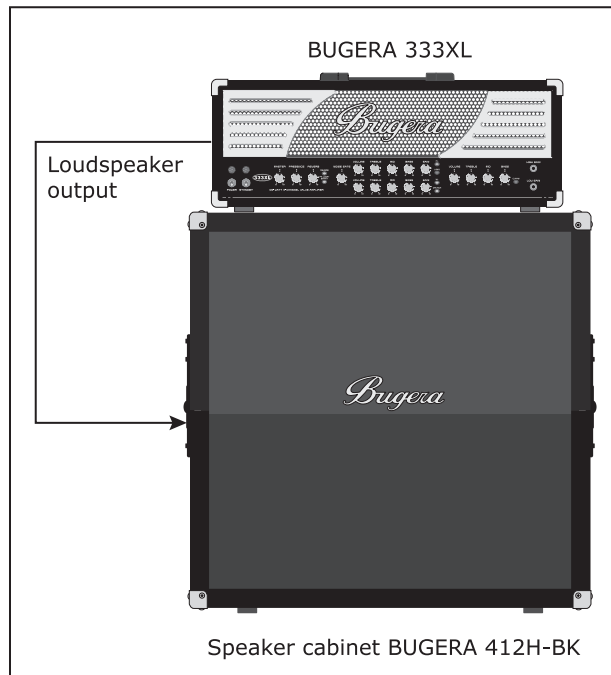

BUGERA head with a speaker cabinet

The following figure shows a setup of the 333XL-212 together with an external effects unit connected over the FX LOOP. And the LINE OUT is connected to the line input of a mixer in order to send the signal to a recording device. The LEVEL control of the LINE OUT lets you adjust the output level of the BUGERA to the input sensitivity of the mixer. In addition, the speaker signal of the BUGERA is picked up by a microphone and is fed to the microphone input of the mixer. This way you get a second guitar signal which then can be amplified by a PA system and/or can be recorded as well.

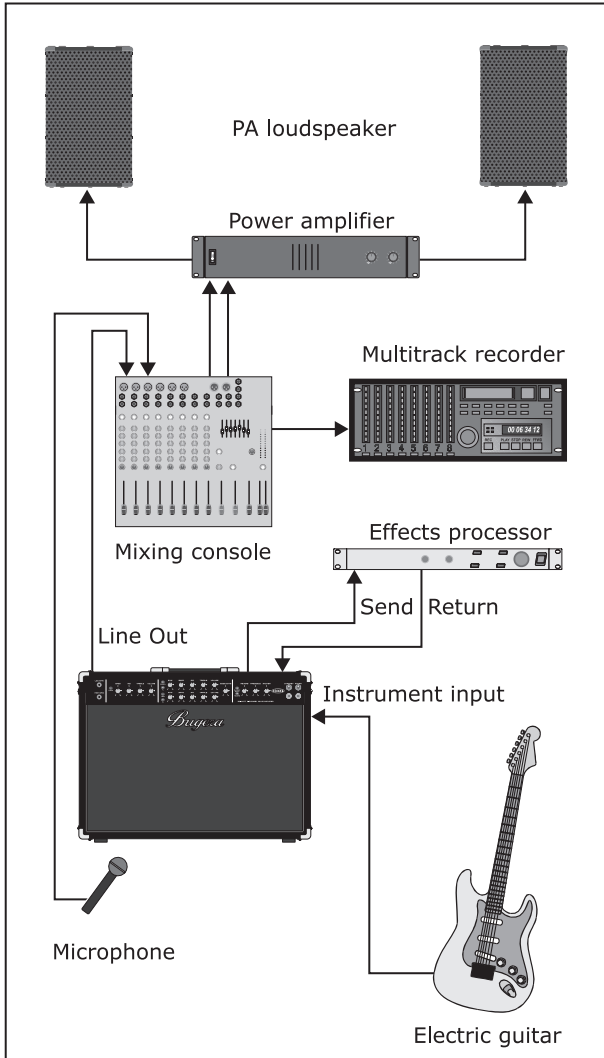

Live setup with a BUGERA combo

Audio connections

The inputs and outputs of the BUGERA amplifier use mono jack connectors.

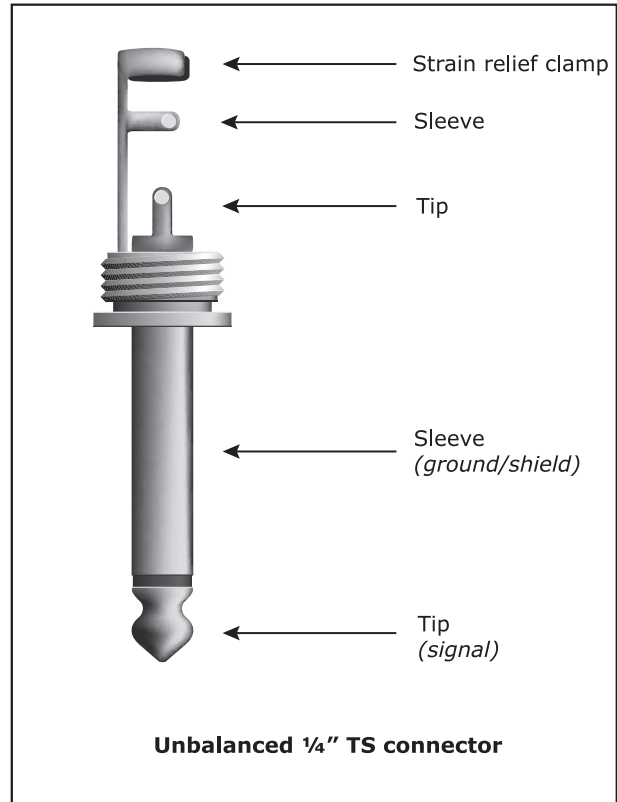

1/4" mono jack connector

Specifications

PREAMP SECTION

Valves

Type	1 x 12AX7A 1 x 12AX7B 2 x 12AX7C
------	--

Preamp high-gain input

Impedance	470 k Ω
-----------	----------------

Clean channel

Nominal input level	-20 dBV
Min. input level	-30 dBV
Max. input level	0 dBV

Crunch channel

Nominal input level	-80 dBV
Min. input level	-90 dBV

Lead channel

Nominal input level	-80 dBV
Min. input level	-90 dBV

Preamp low-gain input (only 333XL and 333XL-212)

Impedance	44 k Ω
All levels attenuated by	+6 dB

Effects send

Impedance	47 k Ω or higher
Min. output level	-10 dBV, 300 mV RMS
Max. output level	0 dBV, 1 V RMS

Effects return

Impedance	470 k Ω
Min. input sensitivity	-10 dBV
Max. input sensitivity	0 dBV

Line output

Impedance	47 k Ω or higher
Adjustable output level	\pm 20 dBV

POWER AMPLIFIER SECTION

Valves

Type	4 x 6L6GC (333 and 333-212) 4 x EL34 (333XL and 333XL-212)
------	---

Output power

Peak power	120 W / 16, 8, 4 Ω
------------	---------------------------

Loudspeaker connectors

Type	¼" mono jack connectors, unbalanced
Load impedance	4 Ω / 8 Ω / 16 Ω switchable

Internal loudspeakers (only 333XL-212 and 333-212)

Type	2 x 12" BUGERA, 12G70J8
Impedance	8 Ω
Continuous power	70 W (IEC)
Total impedance	16 Ω (series connection)

POWER SUPPLY

U.S./Canada	120 V \sim , 60 Hz
China	220 V \sim , 50 Hz
Korea	220 V \sim , 60 Hz
Europe/U.K./Australia	230 V \sim , 50 Hz
Japan	100 V \sim , 50/60 Hz
General export model	120/230 V \sim , 50/60 Hz
Power consumption	Max. 350 W
Fuse	T 3.15 A H 250 V (100 – 120 V \sim , 50/60 Hz) T 1.6 A H 250 V (220 – 230 V \sim , 50/60 Hz)
Mains connection	Standard IEC receptacle

DIMENSIONS/WEIGHT

333

Dimensions (H x W x D)	Approx. 9 25/32" x 27" x 9 11/16" (249 mm x 687.3 mm x 246 mm)
Weight	Approx. 47 lbs (21.5 kg)

333-212

Dimensions (H x W x D)	Approx. 20 13/32" x 27" x 9 3/4" (518.46 mm x 687.3 mm x 247.65 mm)
Weight	Approx. 63 lbs (28.5 kg)

333XL

Dimensions (H x W x D)	Approx. 9 25/32" x 27" x 9 11/16" (249 mm x 687.3 mm x 246 mm)
Weight	Approx. 47 lbs (21.5 kg)

333XL-212

Dimensions (H x W x D)	Approx. 20 13/32" x 27" x 9 3/4" (518.46 mm x 687.3 mm x 247.65 mm)
Weight	Approx. 63 lbs (28.5 kg)

We are constantly striving to maintain the highest professional standards. As a result of these efforts, modifications may be made from time to time to existing products without prior notice. Specifications and appearance may differ from those listed or illustrated.

Limited warranty

SPECIAL NOTE: NO USER SERVICEABLE PARTS INSIDE. REFER SERVICING TO QUALIFIED PERSONNEL ONLY.

§ 1 Other warranty rights and national law

1. This limited warranty does not exclude or limit the buyer's statutory rights provided by national law, in particular, any such rights against the seller that arise from a legally effective purchase contract.
2. The limited warranty regulations mentioned herein are applicable unless they constitute an infringement of national warranty law.

§ 2 Online registration

Please do remember to register your new BUGERA equipment right after your purchase by visiting <http://www.bugera-amps.com> and kindly read the terms and conditions of our limited warranty carefully. Registering your purchase and equipment with us helps us process your repair claims quicker and more efficiently. Thank you for your cooperation!

§ 3 Limited Warranty

1. BEHRINGER warrants the mechanical and electronic components of this product to be free of defects in material and workmanship if used under normal operating conditions for a period of one (1) year** from the original date of purchase.
2. BEHRINGER warrants valves (tubes) and meters contained in the product to be free of defects in material and workmanship if used under normal operating conditions for a period of 90 days from the original date of purchase.
3. This limited warranty is subject to the conditions, exclusions and limitations hereinafter set forth.
4. If the product shows any defects within the specified warranty period that are not excluded from this warranty as described under § 5, BEHRINGER will, at its discretion, either replace the product by providing a new or reconditioned product or repair the product using suitable new or reconditioned parts. In the case that other parts are used which constitute an improvement, BEHRINGER may, at its discretion, charge the customer for the additional cost of these parts. In case BEHRINGER decides to replace the entire product, this warranty shall apply to the replacement product for the remaining initial warranty period, i.e., one year** from the date of purchase of the initial product.
5. If the warranty claim proves to be justified, the product will be returned to the user freight prepaid.
6. Warranty claims other than those indicated above are expressly excluded.

PLEASE RETAIN YOUR SALES RECEIPT, AS IT IS YOUR PROOF OF PURCHASE COVERING YOUR LIMITED WARRANTY. THIS LIMITED WARRANTY IS VOID WITHOUT SUCH PROOF OF PURCHASE.

§ 4 Return authorization number

1. To obtain warranty service, the buyer (or his authorized dealer) must call BEHRINGER as exclusive distributor of BUGERA products (see enclosed list) during normal business hours BEFORE returning the product. All inquiries must be accompanied by a description of the problem. The buyer or his authorized dealer will receive a return authorization number
2. Subsequently, the product must be returned in its original shipping carton, together with the return authorization number. The return shipment address will be indicated by BEHRINGER.
3. Shipments without freight prepaid will not be accepted.

§ 5 Warranty regulations

1. Warranty services will be furnished only if the product is accompanied by a copy of the original retail dealer's invoice.
2. If the product needs to be modified or adapted in order to comply with applicable technical or safety standards on a national or local level, in any country which is not the country for which the product was originally developed and manufactured, this modification/adaptation shall not be considered a defect in materials or workmanship. This limited warranty does not cover any such modification/adaptation, irrespective of whether it was carried out properly or not. Under the terms of this limited warranty, BEHRINGER shall not be held responsible for any cost resulting from such a modification/adaptation.
3. Free inspections and maintenance/repair work are expressly excluded from this limited warranty, in particular, if caused by improper handling of the product by the user. This also applies to defects caused by normal wear and tear, in particular, of faders, crossfaders, potentiometers, keys/buttons, tubes, guitar strings, illuminants and similar parts.
4. Damage/defects caused by the following conditions are not covered by this limited warranty:
 - ▶ improper handling, neglect or failure to operate the unit in compliance with the instructions given in BEHRINGER user or service manuals
 - ▶ connection or operation of the unit in any way that does not comply with the technical or safety regulations applicable in the country where the product is used.
 - ▶ damage/defects caused by force majeure or any other condition that is beyond the control of BEHRINGER.
5. Any repair or service performed by any person or entity other than a BEHRINGER authorized service center is not covered by this limited warranty.
6. Any repair or opening of the unit carried out by unauthorized personnel (user included) will void this limited warranty.
7. Any exchange of the tubes/valves and associated biasing by any person or entity other than a BEHRINGER authorized service centre will void this limited warranty.
8. If an inspection of the product by BEHRINGER shows that the defect in question is not covered by this limited warranty, the inspection costs are payable by the customer.
9. Products which do not meet the terms of this limited warranty will be repaired exclusively at the buyer's expense. BEHRINGER will inform the buyer of any such circumstance. If the buyer fails to submit a written repair order within 6 weeks after notification, BEHRINGER will return the unit. Costs for freight and packing will be invoiced separately C.O.D. When the buyer has sent in a written repair order, such costs will also be invoiced separately.

§ 6 Warranty transferability

This limited warranty is extended exclusively to the original buyer (customer of retail dealer) and is not transferable to anyone who may subsequently purchase this product.

§ 7 Claim for damages

Failure of BEHRINGER to provide proper warranty service shall not entitle the buyer to claim (consequential) damages. In no event shall the liability of BEHRINGER exceed the invoiced value of the product.

§ 8 U.S. Customers only

THE FOREGOING CONSTITUTES THE ONLY WARRANTY MADE BY BEHRINGER WITH RESPECT TO THE PRODUCT AND IS MADE EXPRESSLY IN LIEU OF ALL OTHER WARRANTIES EXPRESS OR IMPLIED. Any implied warranties, including without limitation, any implied warranties of merchantability or fitness for any particular purpose, imposed under state law are limited to the duration of this limited warranty. Some states do not allow limitations on how long an implied warranty lasts, so the above limitations may not be applicable to you.

BEHRINGER ASSUMES NO LIABILITY FOR PROPERTY DAMAGE RESULTING FROM FAILURE OF THIS PRODUCT NOR ANY LOSS OF INCOME, SATISFACTION OR DAMAGES ARISING FROM THE LOSS OF USE OF SAME DUE TO DEFECTS OR AVAILABILITY OF SAME DURING SERVICE.

**Customers in the European Union please contact BEHRINGER Germany Support for further details.

Technical specifications and appearance are subject to change without notice. The information contained herein is correct at the time of printing. All trademarks (except BUGERA, the BUGERA logo, and THE SOUL OF VALVES) mentioned belong to their respective owners, and such use neither constitutes a claim of the trademarks by RED CHIP COMPANY LTD nor affiliation of the trademark owners with RED CHIP COMPANY LTD. RED CHIP COMPANY LTD accepts no liability for any loss which may be suffered by any person who relies either wholly or in part upon any description, photograph or statement contained herein. Colors and specifications may vary slightly from product. Our Products are sold through authorized dealers only. This manual is copyrighted. No part of this manual may be reproduced or transmitted in any form or by any means, electronic or mechanical, including photocopying and recording of any kind, for any purpose, without the express written permission of RED CHIP COMPANY LTD. BUGERA-products are distributed exclusively by the BEHRINGER Group of companies globally, and specifically by BEHRINGER International GmbH in the European Union. ALL RIGHTS RESERVED. (c) 2008 RED CHIP COMPANY LTD. Trident Chambers, Wickhams Cay, P.O. Box 146, Road Town, Tortola, British Virgin Islands.

FEDERAL COMMUNICATIONS COMMISSION COMPLIANCE INFORMATION



Responsible party name: **MUSIC Group Services USA, Inc.**
Address: **18912 North Creek Parkway,
Suite 200 Bothell, WA 98011,
USA**
Phone/Fax No.: **Phone: +1 425 672 0816
Fax: +1 425 673 7647**

BUGERA 333XL/333XL-212/333/333-212

complies with the FCC rules as mentioned in the following paragraph:

This equipment has been tested and found to comply with the limits for a Class B digital device, pursuant to part 15 of the FCC Rules. These limits are designed to provide reasonable protection against harmful interference in a residential installation. This equipment generates, uses and can radiate radio frequency energy and, if not installed and used in accordance with the instructions, may cause harmful interference to radio communications. However, there is no guarantee that interference will not occur in a particular installation. If this equipment does cause harmful interference to radio or television reception, which can be determined by turning the equipment off and on, the user is encouraged to try to correct the interference by one or more of the following measures:

- Reorient or relocate the receiving antenna.
- Increase the separation between the equipment and receiver.
- Connect the equipment into an outlet on a circuit different from that to which the receiver is connected.
- Consult the dealer or an experienced radio/TV technician for help.

This device complies with Part 15 of the FCC rules. Operation is subject to the following two conditions:

- (1) this device may not cause harmful interference, and
- (2) this device must accept any interference received, including interference that may cause undesired operation.

Important information:

Changes or modifications to the equipment not expressly approved by MUSIC Group can void the user's authority to use the equipment.