

CDP-130

EN/ES

USER'S GUIDE

Please keep all information for future reference.

Safety Precautions

Before trying to use the Digital Piano, be sure to read the separate "Safety Precautions".

GUÍA DEL USUARIO

Guarde toda la información para futuras consultas.

Precauciones de seguridad

Antes de intentar usar el piano digital, asegúrese de leer las "Precauciones de seguridad" separadas.

English

Español

TO REDUCE THE RISK OF FIRE OR ELECTRIC SHOCK, REFER SERVICING TO QUALIFIED SERVICE PERSONNEL.

IMPORTANT SAFETY INSTRUCTIONS

1. Read these instructions.
2. Keep these instructions.
3. Heed all warnings.
4. Follow all instructions.
5. Do not use this apparatus near water.
6. Clean only with dry cloth.
7. Do not block any ventilation openings. Install in accordance with the manufacturer's instructions.
8. Do not install near any heat sources such as radiators, heat registers, stoves, or other apparatus (including amplifiers) that produce heat.
9. Do not defeat the safety purpose of the polarized or grounding-type plug. A polarized plug has two blades with one wider than the other. A grounding type plug has two blades and a third grounding prong. The wide blade or the third prong are provided for your safety. If the provided plug does not fit into your outlet, consult an electrician for replacement of the obsolete outlet.
10. Protect the power cord from being walked on or pinched particularly at plugs, convenience receptacles, and the point where they exit from the apparatus.
11. Only use attachments/accessories specified by the manufacturer.
12. Use only with the cart, stand, tripod, bracket, or table specified by the manufacturer, or sold with the apparatus. When a cart is used, use caution when moving the cart/apparatus combination to avoid injury from tip-over.
13. Unplug this apparatus during lightning storms or when unused for long periods of time.
14. Refer all servicing to qualified service personnel. Servicing is required when the apparatus has been damaged in any way, such as power-supply cord or plug is damaged, liquid has been spilled or objects have fallen into the apparatus, the apparatus has been exposed to rain or moisture, does not operate normally, or has been dropped.



The apparatus shall not be exposed to dripping or splashing and that no objects filled with liquids, such as vases, shall be placed on the apparatus.

The power indicator being unlit does not mean the apparatus is completely disconnected from the MAINS. When you need to have the apparatus completely disconnected from the MAINS, you must unplug the power cord. For that purpose, locate the apparatus in a way that secures easy access to the power cord.

Declaration of Conformity

Model Number: CDP-130

Trade Name: CASIO COMPUTER CO., LTD.

Responsible party: CASIO AMERICA, INC.

Address: 570 MT. PLEASANT AVENUE, DOVER, NEW JERSEY 07801

Telephone number: 973-361-5400

This device complies with Part 15 of the FCC Rules. Operation is subject to the following two conditions:

(1) This device may not cause harmful interference, and (2) this device must accept any interference received, including interference that may cause undesired operation.

NOTICE

This equipment has been tested and found to comply with the limits for a Class B digital device, pursuant to Part 15 of the FCC Rules. These limits are designed to provide reasonable protection against harmful interference in a residential installation. This equipment generates, uses and can radiate radio frequency energy and, if not installed and used in accordance with the instructions, may cause harmful interference to radio communications. However, there is no guarantee that interference will not occur in a particular installation. If this equipment does cause harmful interference to radio or television reception, which can be determined by turning the equipment off and on, the user is encouraged to try to correct the interference by one or more of the following measures:

- Reorient or relocate the receiving antenna.
- Increase the separation between the equipment and receiver.
- Connect the equipment into an outlet on a circuit different from that to which the receiver is connected.
- Consult the dealer or an experienced radio/TV technician for help.

FCC WARNING

Changes or modifications not expressly approved by the party responsible for compliance could void the user's authority to operate the equipment.

Important!

Please note the following important information before using this product.

- Before using the AD-A12150LW Adaptor to power the product, be sure to check the AC Adaptor for any damage first. Carefully check the power cord for breakage, cuts, exposed wire and other serious damage. Never let children use an AC adaptor that is seriously damaged.
- The product is not intended for children under 3 years.
- Use only CASIO AD-A12150LW adaptor.
- The AC adaptor is not a toy.
- Be sure to disconnect the AC adaptor before cleaning the product.

Declaration of Conformity According to EU Directive



This mark applies in EU countries only.



Manufacturer:
CASIO COMPUTER CO., LTD.
6-2, Hon-machi 1-chome, Shibuya-ku, Tokyo 151-8543, Japan

Responsible within the European Union:
CASIO EUROPE GmbH
Casio-Platz 1, 22848 Norderstedt, Germany

- Any reproduction of the contents of this manual, either in part or its entirety, is prohibited. Except for your own, personal use, any other use of the contents of this manual without the consent of CASIO is prohibited under copyright laws.
- IN NO EVENT SHALL CASIO BE LIABLE FOR ANY DAMAGES WHATSOEVER (INCLUDING, WITHOUT LIMITATION, DAMAGES FOR LOSS OF PROFITS, BUSINESS INTERRUPTION, LOSS OF INFORMATION) ARISING OUT OF THE USE OF OR INABILITY TO USE THIS MANUAL OR PRODUCT, EVEN IF CASIO HAS BEEN ADVISED OF THE POSSIBILITY OF SUCH DAMAGES.
- The contents of this manual are subject to change without notice.
- The actual appearance of the product may be different from that shown in the illustrations in this User's Guide.
- Company and product names used in this manual may be registered trademarks of others.

Contents

General GuideEN-3

Getting Ready to PlayEN-4

- Preparing the Music Stand EN-4
- Connecting a Pedal Unit..... EN-4
- Power Supply EN-4

Playing the Digital Piano.....EN-5

- Turning on Power and Playing EN-5
- Using Headphones EN-5
- Using a Damper Pedal EN-6
- Changing Keyboard Response to Touch Pressure (Touch Response)..... EN-6
- Selecting and Playing a Tone..... EN-7
- Playing Demo Songs EN-7
- Layering Two Tones EN-8
- Using Hall EN-8
- Using Reverb..... EN-8
- Using Chorus..... EN-9
- Changing the Pitch (Transpose, Tuning)..... EN-9
- Using the Metronome EN-10

Connecting External DevicesEN-11

- Connecting to a Computer EN-11
- MIDI Settings EN-12
- Outputting Keyboard Notes to Audio Equipment EN-12

ReferenceEN-13

- Troubleshooting..... EN-13
- Specifications EN-14
- Operating Precautions..... EN-15

MIDI Implementation Chart

Included Accessories

- Music Stand
- Pedal
- Leaflets
 - Safety Precautions
 - Other (Warranty, etc.)

Items included as accessories are subject to change without notice.

Separately Available Accessories

- You can get information about accessories that are separately for this product from the CASIO catalog available from your retailer, and from the CASIO website at the following URL.

<http://world.casio.com/>

General Guide

- In this manual, the term “Digital Piano” refers to the CDP-130.
- In this manual, buttons and other controllers are identified using the numbers shown below.

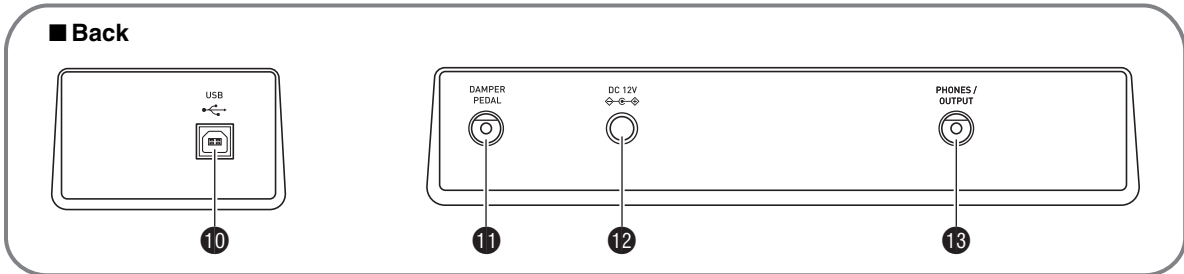
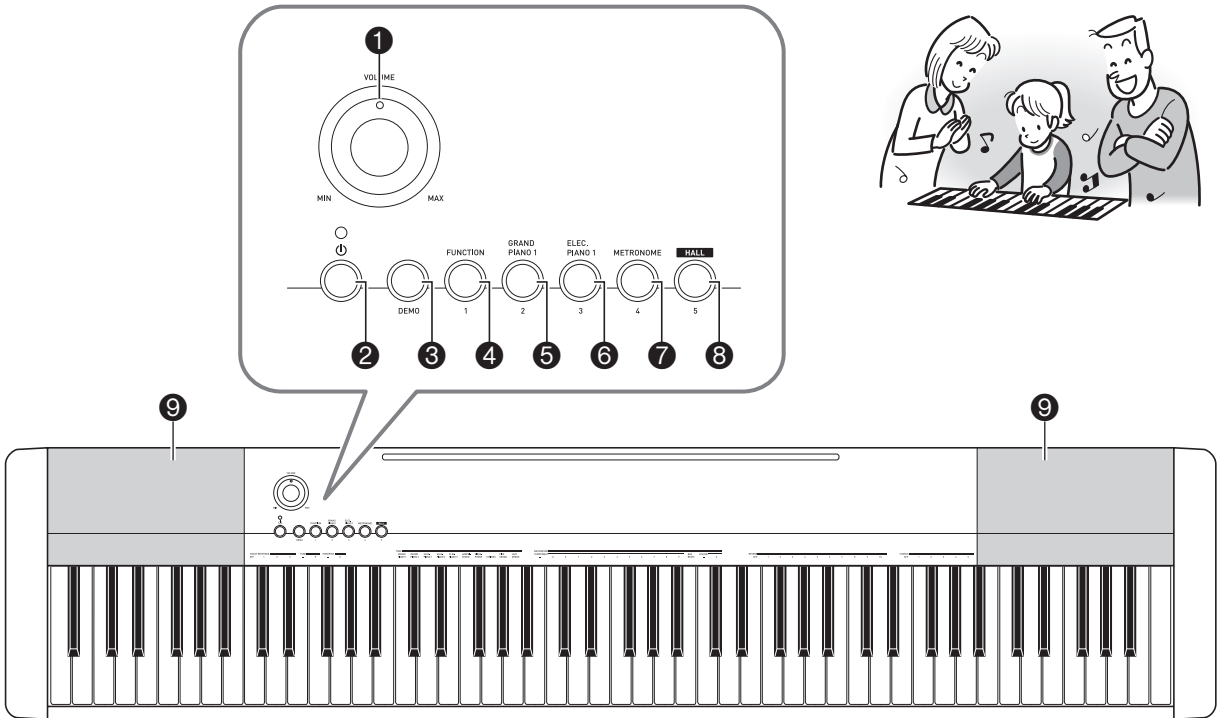

- | | |
|---|--|
| <ul style="list-style-type: none"> ❶ VOLUME knob EN-5 ❷ ⏻ (POWER) button EN-5 ❸ DEMO button EN-7 ❹ FUNCTION button EN-6, 7, 8, 9, 10, 12 ❺ GRAND PIANO 1 button EN-7, 8 ❻ ELEC PIANO 1 button EN-7 ❼ METRONOME button EN-10 | <ul style="list-style-type: none"> ❽ HALL button EN-5, 8 ❾ Speakers ❿ USB port EN-11 ⓫ DAMPER PEDAL jack EN-4 ⓬ DC 12V terminal EN-4 ⓭ PHONES/OUTPUT jack EN-5 |
|---|--|



Getting Ready to Play

Preparing the Music Stand

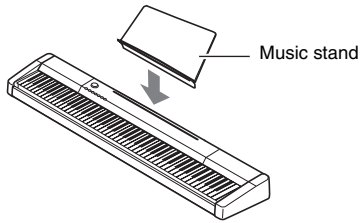

Connecting a Pedal Unit

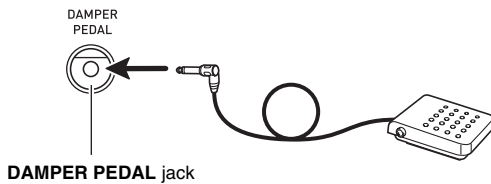

Power Supply

Your Digital Piano runs on standard household power. Be sure to turn off power whenever you are not using the Digital Piano.

Using the AC Adaptor

Use only the AC adaptor (JEITA Standard, with unified polarity plug) that comes with this Digital Piano. Use of a different type of AC adaptor can cause malfunction of the Digital Piano.

Specified AC Adaptor: AD-A12150LW

- Use the supplied power cord to connect the AC adaptor as shown in the illustration below.

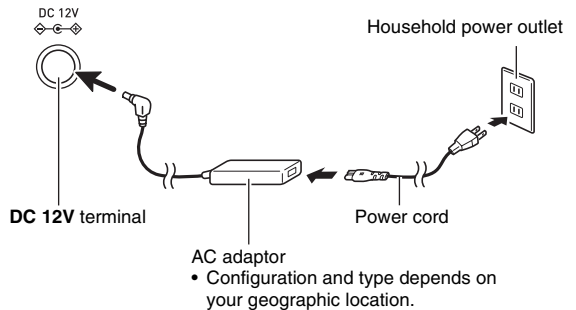

Note the following important precautions to avoid damage to the power cord.

During Use

- Never pull on the cord with excessive force.
- Never repeatedly pull on the cord.
- Never twist the cord at the base of the plug or connector.

During Movement

- Before moving the Digital Piano, be sure to unplug the AC adaptor from the power outlet.

During Storage

- Loop and bundle the power cord, but never wind it around the AC adaptor.

IMPORTANT!

- **Never connect the AC adaptor (JEITA Standard, with unified polarity plug) that comes with this Digital Piano to any other device besides this Digital Piano. Doing so creates the risk of malfunction.**
- **Make sure the Digital Piano is turned off before plugging in or unplugging the AC adaptor.**
- **The AC adaptor will become warm to the touch after very long use. This is normal and does not indicate malfunction.**

Playing the Digital Piano

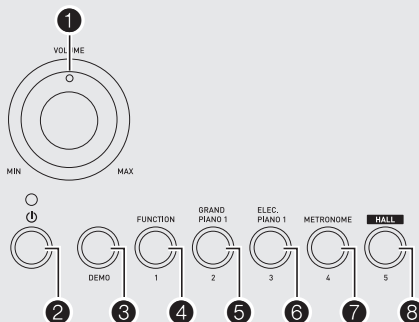

Turning on Power and Playing

1. Press ② (⏻).

This turns on power.

- To turn off the Digital Piano, press ② again.

2. Try playing something on the keyboard. Use ① to adjust volume.

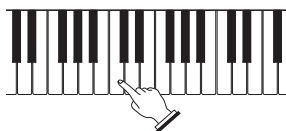

IMPORTANT!

- Turning off the Digital Piano causes most current settings to be cleared. The Digital Piano will revert to initial settings the next time you turn it on. Once you turn it on it remains on until you turn it off again.
- Pressing ② to turn off power actually puts the Digital Piano into a standby state. Minute amounts of current continue to flow within the Digital Piano in the standby state. If you do not plan to use the Digital Piano for a long time or if there is a lightning storm in your area, be sure to unplug the AC adaptor from the power outlet.

Auto Power Off

If you do not perform any operation for 30 minutes, the Digital Piano will turn off automatically.

Disabling Auto Power Off

You can disable Auto Power Off to ensure that power is not turned off automatically during a concert, etc.

1. While holding down ⑧, turn on power.

Auto Power Off will be disabled.

Using Headphones

Using headphones cuts off output from the built-in speakers, which means you can practice playing even late at night without disturbing others.

- Be sure to turn down the volume level before connecting headphones.

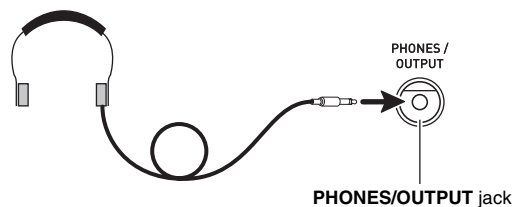

NOTE

- Headphones do not come with the Digital Piano.
- Use commercially available headphones. See page EN-2 for information about options.

IMPORTANT!

- Do not listen to very high volume output over headphones for long period. Doing so creates the risk of hearing damage.
- If you are using headphones that require an adaptor plug, make sure you do not leave the adaptor plugged in when removing the headphones.

Using a Damper Pedal

Connecting a pedal to the **DAMPER PEDAL** jack makes it possible to use the pedal as a damper pedal (page EN-4). Pressing the damper pedal while playing will cause the notes you play to reverberate for a very long time.

Changing Keyboard Response to Touch Pressure (Touch Response)

Touch Response alters tone volume in accordance with keyboard pressure (speed). This provides you some of the same expressivity you get on an acoustic piano.



Pressing fast produces louder notes.

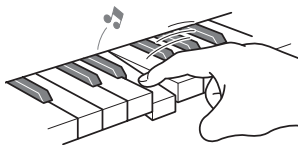

Pressing slowly produces softer notes.

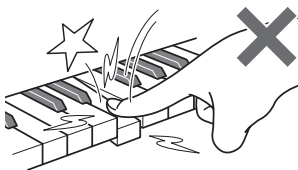

Do not try to use too much pressure.

Changing Touch Response Sensitivity

Use the procedure below to control how much the volume of played notes change in accordance with playing speed. Select the setting that best matches your playing style.

1. While holding down **4**, press one of the keys in the **TOUCH RESPONSE** area of the keyboard to specify the Touch Response sensitivity.

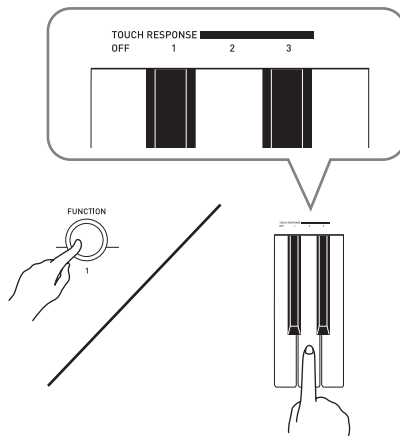

Off (OFF)	Touch Response is turned off. Sound volume is fixed, regardless of key press speed.
Type1 (1)	Normal Touch Response
Type2 (2)	More sensitive Touch Response than Type 1
Type3 (3)	Less sensitive Touch Response than Type 1

- The initial default Touch Sensitivity setting is Type1.

Selecting and Playing a Tone

The Digital Piano comes with 10 built-in tones.

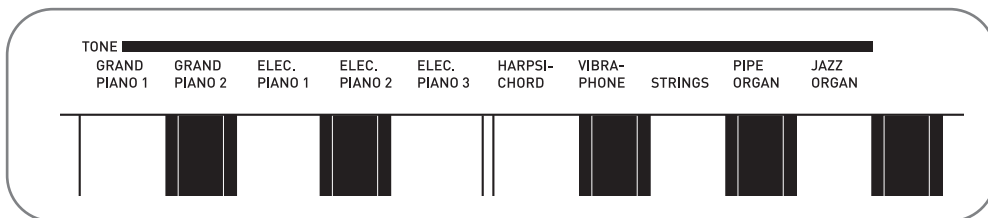

- The names of the tones are marked above the keyboard keys to which they are assigned.

To select a tone

1. Select the tone you want.

To select GRAND PIANO 1 or ELEC PIANO 1

- Press one of **5** or **6** to select the one you want.

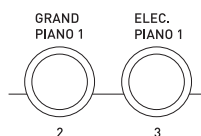

To select one of the other tones

- While holding down **4**, press the keyboard key that corresponds to the tone you want to select.

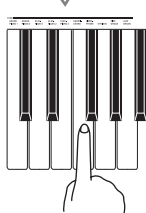
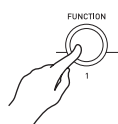
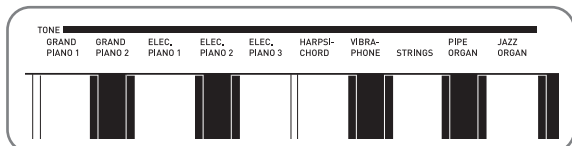

Playing Demo Songs

Your Digital Piano comes with five built-in demo tunes.

Song No.	Song Name
1	Prélude [Suite bergamasque]
2	Étude Op.25-9 "Butterflies"
3	Original
4	Gavotte [Französische Suite 5]
5	Nessun Dorma [Turandot]

1. Press **3**.

This will start playback of the demo songs.

2. To change demo playback to a different song, press a button from **4** (Song 1) to **8** (Song 5) to specify a song number.

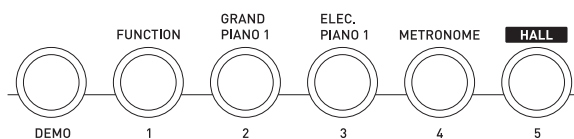

3. Press **3** again to stop playback.

Playback of the demo songs will continue in an endless loop until you press **3** to stop it.

- If Auto Power Off (page EN-5) is enabled, the Digital Piano will turn off if 30 minutes (six minutes under battery power) elapse without any keyboard operation being performed. Use the procedure under "Disabling Auto Power Off" (page EN-5) for information about how to disable Auto Power Off.

Layering Two Tones

You can use the following procedure to layer two different tones (such as piano and strings) so they sound simultaneously when you press a keyboard key.

1. While holding down **4** press down the keyboard key for the first tone you want to layer and then the key for the second tone.

Example: First press the HARPSICHORD key and then the STRINGS key.

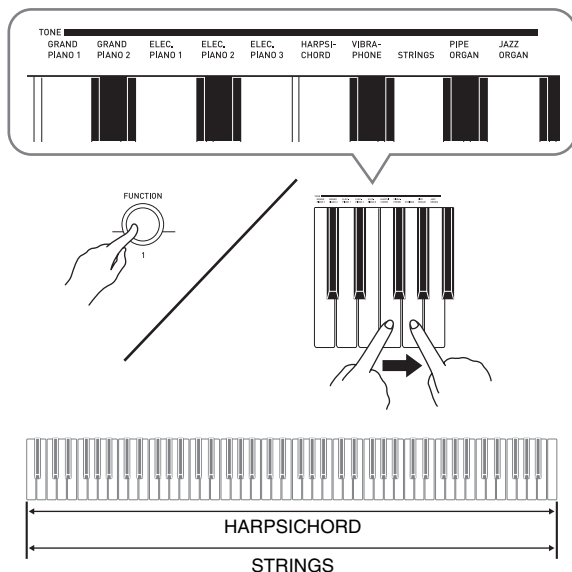

2. To unlayer the keyboard, select another tone by pressing **5** or by using the procedure under “Selecting and Playing a Tone” (page EN-7).

Using Hall

The Hall function lets you instantly configure the Digital Piano to play with the acoustic effect of a classic concert hall.

1. Press **8** (HALL) to turn on the Hall function.
2. To turn off the Hall function, press **8** again.

NOTE

- The initial default Hall function setting is off.
- The reverb setting turns off automatically whenever the Hall function is turned on. When you turn off the Hall function, the reverb setting will return to whatever it was before you turned on the Hall function.

Using Reverb

Reverb adds reverberation to notes. You can change the duration of the reverb.

1. While holding down **4**, press a key within the REVERB area of the keyboard to adjust the reverb length.

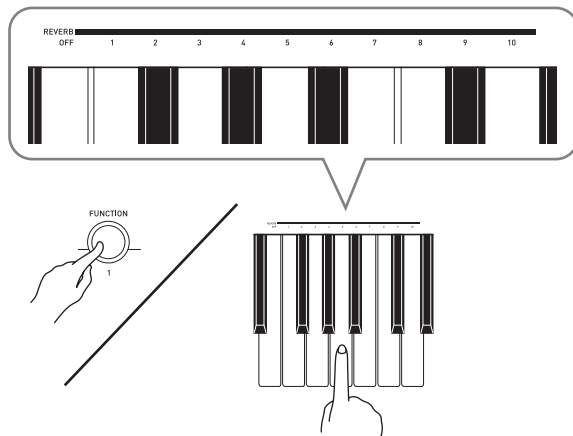

OFF	Turns off reverb.
1 to 10	The larger the number selected, the longer the reverb duration.

NOTE

- The initial default reverb setting is 6.
- Changing the reverb setting (including turning it off) while the Hall function is turned on will turn off the Hall function.

Using Chorus

Chorus is a function that adds depth and breadth to notes. It makes you sound as if you are playing multiple instruments.

1. While holding down **4**, press a key within the **CHORUS** area of the keyboard to select a chorus type.

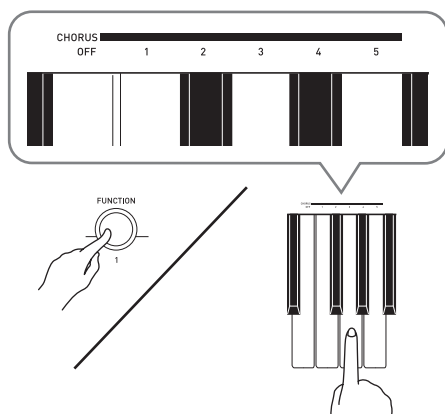

There are five chorus types, plus an off setting.

- The actual effect produced by chorus depends on the tone you are using.
The initial default chorus setting is OFF.

Changing the Pitch (Transpose, Tuning)

Changing the Pitch in Semitone Steps (Transpose)

The transpose feature lets you change the pitch, in semitone steps. A simple operation lets you instantly change the pitch to match that of a singer.

- The transpose setting range is -12 to +12 semitones.
The initial default transpose setting is 0.

1. While holding down **4**, press the minus (-) or plus (+) key within the **TRANPOSE** area of the keyboard to change the setting.

- Each press of a key increases or decreases the current setting by 1.
- To return to the initial default setting, press the minus (-) and plus (+) keys at the same time.

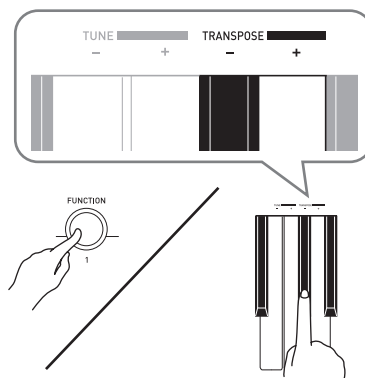

Fine Tuning (Tuning)

Use the tuning feature when you need to adjust the pitch slightly to play along with another musical instrument. Also, some artists perform their music with slightly altered tuning. You can use the tuning feature to adjust tuning so it exactly matches a performance on a CD.

- The tuning feature specifies the frequency of the A4 note. You can set a frequency within the range of 415.5 to 465.9 Hz. The initial default setting is 440.0 Hz.

1. While holding down **4**, press the minus (-) or plus (+) key within the **TUNE** area of the keyboard to change the tuning.

- Each press of a key increases or decreases the current setting by 0.1 Hz.
- To return to the initial default setting (440.0 Hz), press the minus (-) and plus (+) keys at the same time.

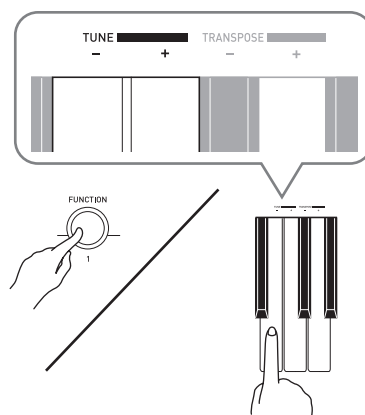

Using the Metronome

1. Press **7**.

- This starts the metronome.

2. To change the beat, hold down **4** as you press the **BAR BEATS** key.

- Keep **4** depressed as you advance to step 3, below.

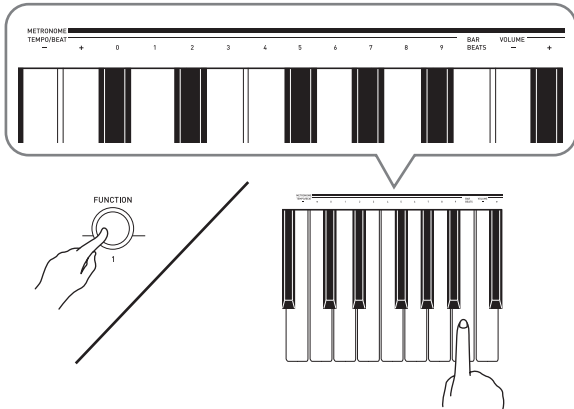

3. Hold down **4** as you press one of the **METRONOME TEMPO/BEAT** keys to select a beat setting.

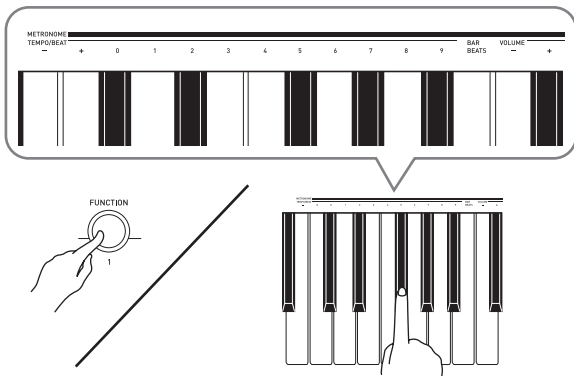

- You can specify beats per measure value of 0, 1, 2, 3, 4, 5, 6, 7, 8, or 9. Specifying 0 as the setting plays a straight click, without any chime. This setting lets you practice with a steady beat.

4. While holding down **4**, use the **METRONOME TEMPO/BEAT** keys to specify a tempo value in the range of 30 to 255 beats per minute.

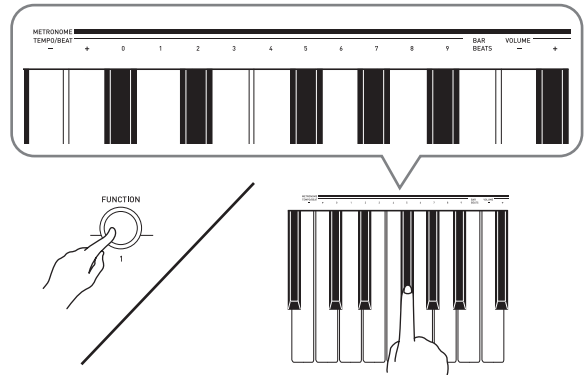

- Each press of the + or – key raises or lowers the tempo value by 1.
- You can use the value input keys (0 to 9) to enter a specific three-digit. Be sure to input all three digits. *Example:* To enter “96”, press keys 0, 9, 6.

5. Press **7** to turn off the metronome.

NOTE

- To return to the initial default setting (tempo value:120), press the + and – keys at the same time in step 4.

To adjust the metronome volume

You can perform the following procedure at any time, regardless of whether or not the metronome is sounding.

1. While holding down **4**, use the **METRONOME VOLUME** keys to change a volume value in the range of 0 to 42.

- Each press of the + or – key raises or lowers the metronome volume value by 1.

NOTE

- To return to the initial default setting, press – and + at the same time.

Connecting External Devices

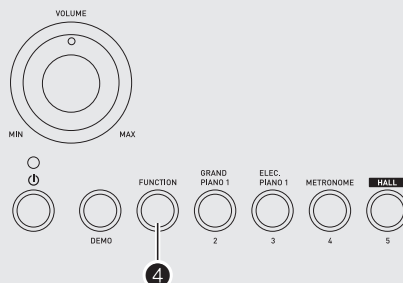

Connecting to a Computer

You can connect the Digital Piano to a computer and exchange MIDI data between them. You can send play data from the Digital Piano to commercially available music software running on your computer, or you can send MIDI data from your computer to the Digital Piano for playback.

Minimum Computer System Requirements

The following shows the minimum computer system requirements for sending and receiving MIDI data. Check to make sure that your computer complies with these requirements before connecting the Digital Piano to it.

• Operating System

Windows® XP (SP2 or later) *1

Windows Vista® *2

Windows® 7 *3

Windows® 8 *4

Mac OS® X (10.3.9, 10.4.11, 10.5.X, 10.6.X, 10.7.X, 10.8.X)

*1: Windows XP Home Edition

Windows XP Professional (32-bit)

*2: Windows Vista (32-bit)

*3: Windows 7 (32-bit, 64-bit)

*4: Windows 8 (32-bit, 64-bit)

• USB port

! IMPORTANT!

- **Never connect to a computer that does not conform to the above requirements. Doing so can cause problems with your computer.**

Connecting the Digital Piano to Your Computer

! IMPORTANT!

- **Make sure you follow the steps of the procedure below exactly. Connecting incorrectly can make data send and receive impossible.**

1. Turn off the Digital Piano and then start up your computer.

- Do not start up the music software on your computer yet!

2. After starting up your computer, use a commercially available USB cable to connect it to the Digital Piano.

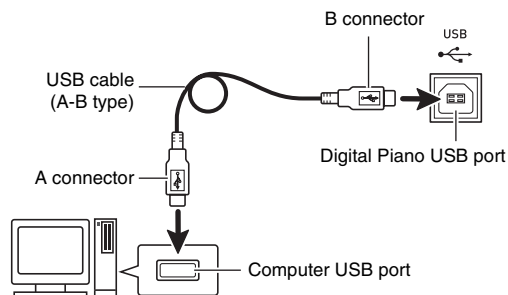

3. Turn on the Digital Piano.

- If this is the first time you are connecting the Digital Piano to your computer, the driver software required to send and receive data will be installed on your computer automatically.

4. Start up commercially available music software on your computer.

5. Configure the music software settings to select one of the following as the MIDI device.

CASIO USB-MIDI : For Windows Vista, Windows 7, Windows 8, Mac OS X

USB Audio Device : For Windows XP

- For information about how to select the MIDI device, see the user documentation that comes with the music software you are using.

IMPORTANT!

- Be sure to turn on the Digital Piano first before starting up your computer's music software.

NOTE

- Once you are able to connect successfully, there is no problem with leaving the USB cable connected when you turn off your computer and/or Digital Piano.
- This Digital Piano conforms to General MIDI Level 1 (GM).
- For detailed specifications and connections that apply to MIDI data send and receive by this Digital Piano, see the latest support information provided by the website at the following URL.

<http://world.casio.com/>

MIDI Settings

Keyboard Channel

A keyboard channel is the channel used for sending Digital Piano data to a computer. You can select the channel you want for sending Digital Piano data to a computer.

- The keyboard channel setting range is 01 to 16. The initial default keyboard channel setting is 01.

1. While holding down **F**, press the minus (-) or plus (+) key within the **KEYBOARD CH** area of the keyboard to change the keyboard channel.

- Each press of a key increases or decreases the current setting by 1.
- To return to the initial default setting (01), press the minus (-) and plus (+) keys at the same time.

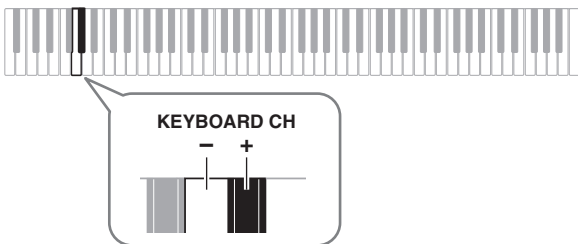
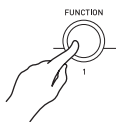

Local Control

There are times when exchanging data with a computer when you may not want the Digital Piano to sound notes you play on its keyboard. The local control setting lets you do just that.

1. While holding down **F**, press a key within the **LOCAL** area of the keyboard to change the local control setting.

- The initial default local control setting is ON. Selecting OFF for this setting disables output from the Digital Piano's speakers.

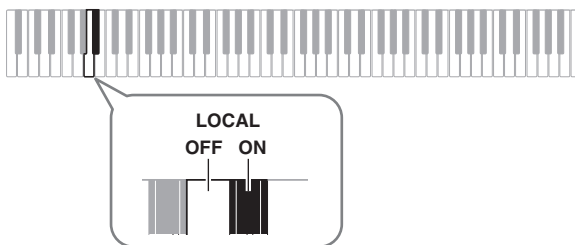
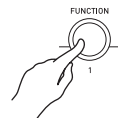

Outputting Keyboard Notes to Audio Equipment

Connection requires commercially available connecting cords, supplied by you. The connecting cords should have a stereo standard plug on one end and a plug that matches the configuration of the external device on the other end.

IMPORTANT!

- Turn off the external device when making connections. After connecting, turn down the Digital Piano and external device volume levels whenever turning power on or off.
- After connecting, turn on the Digital Piano and then the external device.
- If keyboard notes sound distorted when they are sounded from external audio equipment, lower the Digital Piano's volume setting.

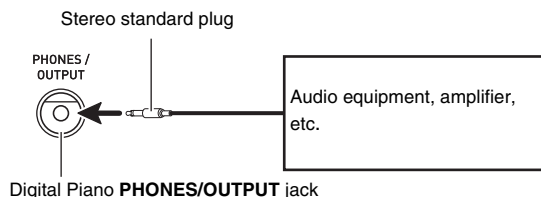

Troubleshooting

Symptom	Action
Included Accessories	
I can't find something that should be here.	Carefully check inside all of the packing materials.
Power Requirements	
Power will not turned on.	Correctly attach the AC adaptor (page EN-4).
Sound	
Nothing happens when I press any keyboard key.	Adjust the volume setting (page EN-5).
Notes keep sounding, without stopping.	Turn power off and then back on to initialize all Digital Piano settings (page EN-5).
Some notes are cut off while they are playing.	Notes are cut off whenever the number of notes being sounded exceeds the maximum polyphony value of 48 (24 for some tones). This does not indicate malfunction.
The volume or tone setting I made has changed.	<ul style="list-style-type: none"> Adjust the volume setting (page EN-5). Turn power off and then back on to initialize all Digital Piano settings (page EN-5).
Output volume does not change even though is change my keyboard touch.	<ul style="list-style-type: none"> Change the Touch Response setting (page EN-6). Turn power off and then back on to initialize all Digital Piano settings (page EN-5).
In certain keyboard ranges, the volume and tone quality sound are slightly different from those in other keyboard ranges.	This is due to system limitations. It does not indicate malfunction.
With some tones, octaves do not change at the far ends of the keyboard.	This is due to system limitations. It does not indicate malfunction.
The pitch of the notes does not match other accompanying instruments or sounds strange when played long with other instruments.	<ul style="list-style-type: none"> Check and adjust the transpose (page EN-9) and tuning settings (page EN-9). Turn power off and then back on to initialize all Digital Piano settings (page EN-5).
The reverb of notes seems to change suddenly.	<ul style="list-style-type: none"> Check and adjust the reverb setting (page EN-8). Turn power off and then back on to initialize all Digital Piano settings (page EN-5).
Computer Connection	
I can't exchange data between the Digital Piano and a computer.	<ul style="list-style-type: none"> Check to make sure that the USB cable is connected to the Digital Piano and computer, and that the device is selected correctly with your computer's music software settings (page EN-11). Turn off the Digital Piano and then exit the music software on your computer. Next, turn the Digital Piano back on and then restart the music software on your computer.

Specifications

Model	CDP-130BK/CDP-130SR
Keyboard	88-key piano keyboard
Touch Response	3 types, Off
Maximum Polyphony	48 notes (24 for certain tones)
Tones	
Built-in Tones	10; with layer
Hall	On, Off
Reverb	1 to 10, Off
Chorus	1 to 5, Off
Demo Songs	5 songs
Metronome	
Beats	0, 1, 2, 3, 4, 5, 6, 7, 8, 9
Tempo Range	30 to 255
Other Functions	
Transpose	±1 octaves (-12 to +12 semitones)
Tuning	A4 = 415.5 to 465.9Hz (Initial Default: 440.0Hz)
MIDI	16 multi-timbre received
Inputs/Outputs	
USB port	TYPE B
Damper Pedal jack	Standard jack
Phones/Output jack	Stereo standard jack
	Output Impedance: 3Ω, Output Voltage: 1.5V (RMS) MAX
Power Jack	12V DC
Power Supply	
AC Adaptor	AD-A12150LW
Auto Power Off	30 minutes after last key operation. Auto Power Off can be disabled. • The AC adaptor can be used safely in areas up to 4,000 meters above sea level.
Speakers	(12cm × 6cm oval) × 2
Output	8W + 8W
Power Consumption	12V --- 18W
Dimensions	132.2 × 28.6 × 12.9cm (52 1/16 × 11 1/4 × 5 1/16 inch)
Weight	Approximately 10.8kg (23.8 lbs)

- Design and specifications are subject to change without notice.

Operating Precautions

Be sure to read and observe the following operating precautions.

■ Location

Avoid the following locations for this product.

- Areas exposed to direct sunlight and high humidity
- Areas subjected to temperature extremes
- Near a radio, TV, video deck, or tuner

The above devices will not cause malfunction of the product, but interference from the product can cause audio or video interference of a nearby device.

■ User Maintenance

- Never use benzine, alcohol, thinner, or other chemical agents to clean the product.
- To clean the product or its keyboard, wipe with a soft cloth moistened in a weak solution of water and a mild neutral detergent. Wring all excess moisture from the cloth before wiping.

■ Included and Optional Accessories

Use only accessories that are specified for use with this product. Use of unauthorized accessories creates the risk of fire, electric shock, and personal injury.

■ Weld Lines

Lines may be visible on the exterior of the product. These are “weld lines” that result from the plastic molding process. They are not cracks or scratches.

■ Musical Instrument Etiquette

Always be aware of others around you whenever using this product. Be especially careful when playing late at night to keep the volume at levels that do not disturb others. Other steps you can take when playing late at night are closing the window and using headphones.

MIDI Implementation Chart

Function	Transmitted	Recognized	Remarks
Basic Channel Default Changed	1 1 - 16	1 - 16 1 - 16	
Mode Default Messages Altered	Mode 3 X * * * * * * * * * *	Mode 3 X * * * * * * * * * *	
Note Number True voice	0 - 127 * * * * * * * * * *	0 - 127 0 - 127 *1	*1:Depends on tone *1:Depende del tono
Velocity Note ON Note OFF	0 9nH v = 1 - 127 X 9nH v = 0	O 9nH v = 1 - 127 X 9nH v = 0, 8nH v = **	** :no relation ***:sin relación
After Touch Key's Ch's	X X	X O	
Pitch Bender	O	O	
0, 32 1 6, 38 7 10 11	O X O O O X	O (MSB only) O O O O O O	Bank select Modulation Data entry *2 Volume Pan Expression
Control Change			

64 66 67 91 93 100, 101		O X X X O X	O O O O O O	Hold 1 Sostenuto Soft pedal Reverb send *3 Chorus send RPN LSB, MSB *2
Program Change : True #		O *** ** ** ** *	O 0 - 127	
System Exclusive		O	O	*2
System Common : Song Pos : Song Sel : Tune		X X X	X X X	
System Real Time : Clock : Commands		O O	X X	
Aux Messages : All sound off : Reset all controller : Local ON/OFF : All notes OFF : Active Sense : Reset		X O X O X X	O O X O O X	
Remarks	*2: For details, see MIDI Implementation at http://world.casio.com/ . *2: Si desea más información, vea Implementación MIDI en http://world.casio.com/ . *3: With this product, the Hall function is treated as one type of reverb. *3: En este producto, la función Hall se considera como un tipo de reverberación.			

Mode 1 : OMNI ON, POLY
Mode 3 : OMNI OFF, POLY

Mode 2 : OMNI ON, MONO
Mode 4 : OMNI OFF, MONO

O : Yes
X : No



This recycle mark indicates that the packaging conforms to the environmental protection legislation in Germany.

Esta marca de reciclaje indica que el empaquetado se ajusta a la legislación de protección ambiental en Alemania.

CASIO®

CASIO COMPUTER CO.,LTD.
6-2, Hon-machi 1-chome
Shibuya-ku, Tokyo 151-8543, Japan

© MA1310-A Printed in China



CDP130-ES-1A

© 2013 CASIO COMPUTER CO., LTD.