

BEAM Communications Pty Ltd
 8 Anzed Court, Mulgrave
 Victoria, 3170, AUSTRALIA
 Web: www.beamcommunications.com
 Info: info@beamcommunications.com
 Support: support@beamcommunications.com
 Tel: +61 3 8588 4500
 Fax: +61 3 9560 9055



ISD700
 Directional/Fixed Antenna
 (Passive)

Installation Guide



Suitable for IsatDocks

PART #: USRMAN006502

Antenna Coverage

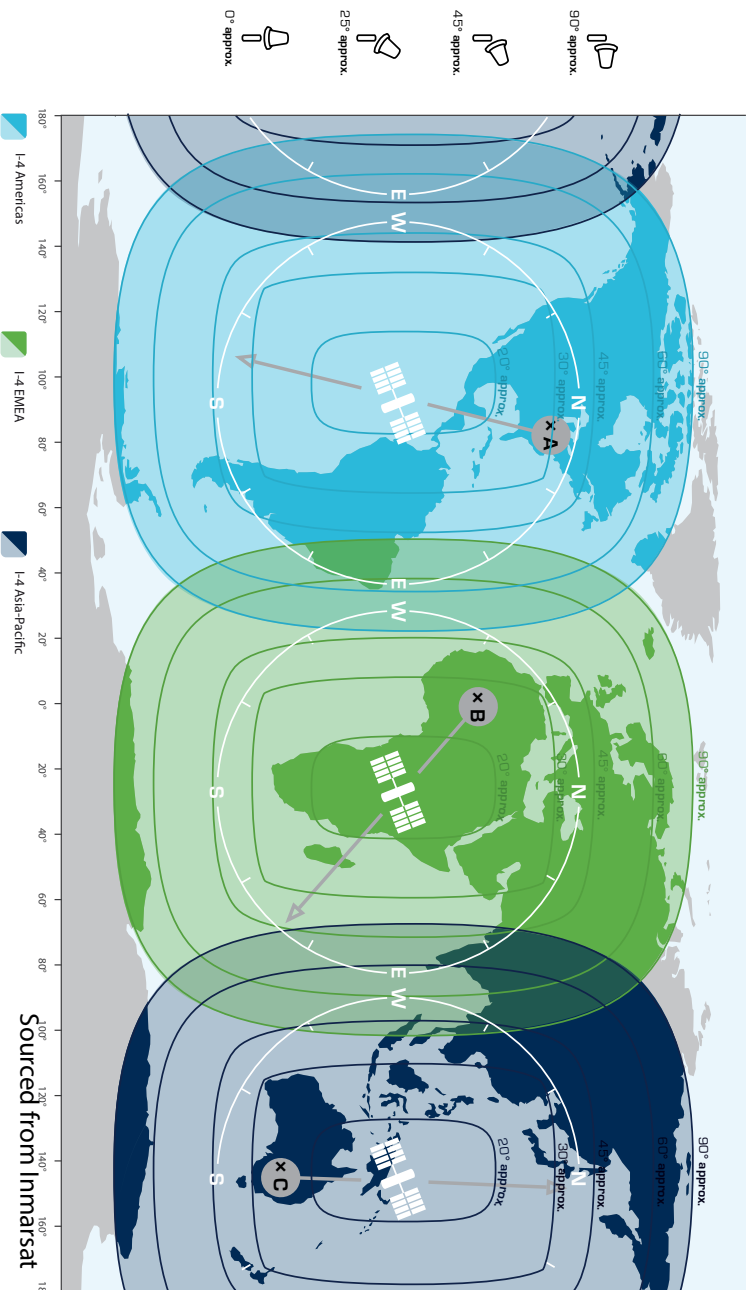
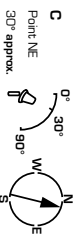
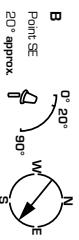
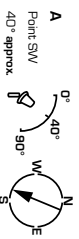

Directional/Fixed Antenna Installation Guide

Step One:

Place the mounting arm in the mounting swivel and use a hex allen key to tighten the two grub screws.

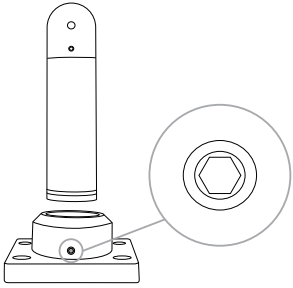

Step Two:

Place the Antenna on the mounting arm and hold in place. Use the hex bolt and split washer to attach the antenna to the mounting arm and loosely screw them together with the hex allenkey provided.



Step Three:

You have a number of options for fitting the antenna in position.

Option A

Fixing the antenna swivel to a flat surface.



Option B

Fixing the antenna swivel to a 90° surface.

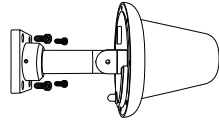

Option C

Fixing the antenna swivel to a pole.

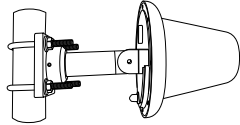

Step Four:

There is a label on the underside of the antenna which indicates "THIS SIDE UP". Ensure when fitting the antenna in the desired location that this label is facing the sky.

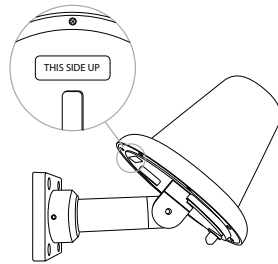

Step Five:

Once the mounting swivel has been fitted in the correct position the incline angle of the antenna will need to be secured. On the inside of the mounting arm is another hex grub screw. Once the antenna has been put on the correct incline position, tighten the grub screw to hold the antenna position in place.

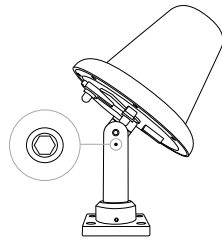

Installation Guidelines

To ensure maximum performance of the antenna system and to maximise availability and reliability of service the antenna must:

- have a clear line of site to the sky
- be clear and free of obstructions
- be clear of metal objects
- be located away from other transmitting devices
- be securely affixed in location
- not be located indoors
- be installed in conjunction with a certified cable

Installing Antenna Cables

When installing antenna cables, follow these guidelines:

- Route and restrain cables to prevent them from vibrating or moving under normal conditions, which could result in damage to the antenna or the coaxial cable connections.
- Wherever the cables contact structures, protect the cables from chafing or abrasion. If a cable needs to be bent, avoid kinking it, and ensure that each bend radius follows the cable supplier limits.
- Use coaxial sealant, shrink-wrap tubing, electrical tape, or another suitable product to seal all cable connections appropriately to prevent moisture and corrosion damage from weather exposure.
- Mount all antennas clear of nearby metal obstructions.

Installation Options

The antenna system is suitable for stationary and fixed applications and is designed to meet Inmarsat System performance requirements when installed according to the instructions in this guide.

The following figure shows typical Installations:

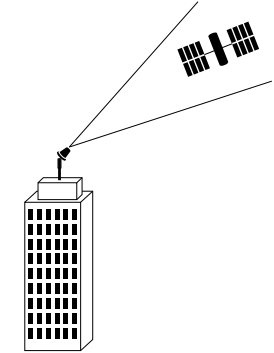

The antenna must be installed without obstruction of other instruments or structures. The antenna must not be positioned within range of radar equipment or other RF interference.

Directional/Fixed Antenna Kit Contents

1. Directional/Fixed Antenna
2. 2 x U Bolts
3. 4 x Large Flat Washers
4. 4 x Nuts
5. Screw with Hex
6. Split Washer
7. Mounting Bracket
8. Mounting Pole
9. Underside of antenna showing antenna and GPS connections.
10. Allen Key

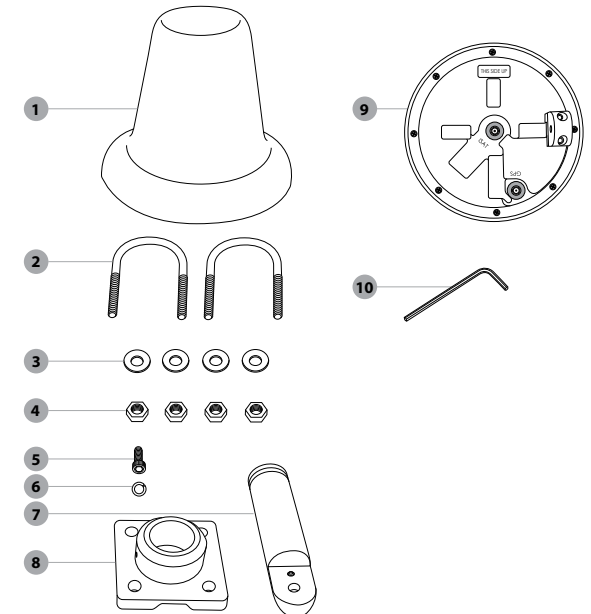

NOTE:

For Satellite & GPS connection instructions please consult your Beam Inmarsat Product manual.